

Design Data	
Commutation	Brushed
Direction of rotation	Bi-directional
Bearing type	A:Ball - B:Sleeve

Performance data		
Rated voltage [V]	$U_N$	24
Nominal torque [Nm]	$M_N$	5.00
No-load speed [ $\text{min}^{-1}$ ]	$n_0$	52.0
Nominal power [W]	$P_N$	25.7
Nominal current [A]	$I_N$	5.0
Nominal force [kN]	$F_N$	0.00
Duty cycle	s1	

Sensor data	
Pulses	0
Output channels	0

Other data	
Gear ratio	59/1
Gear wheel material	Resinbonded fabric
Suppression components	
Enclosure class	IP 20
Weight [kg]	2.900

Remarks: d = M8 x 23mm

### Characteristic curves

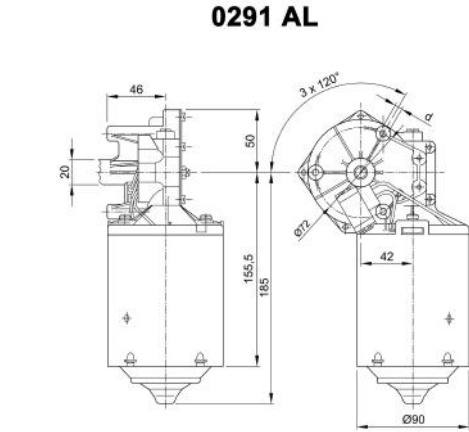

### Motor picture

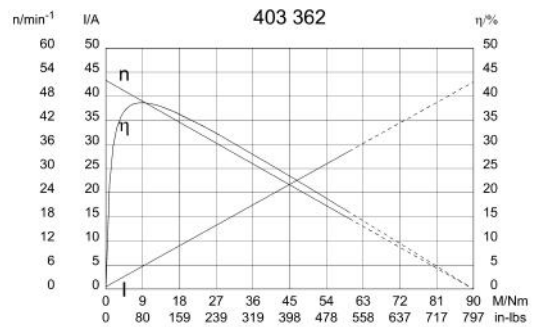

### Output shaft drawing (W), Wiring diagrams (S) and Connector layout (K)

#### W 126

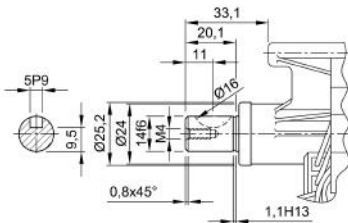

#### S 28

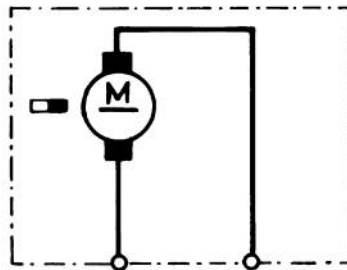

#### K 243

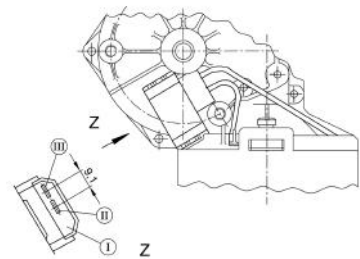

Flat plug 6,8x0,8 DIN 46244 mating with receptacle for tabs and connector housing 163 006-1, drwg C163006, [www.tycoelectronics.com](http://www.tycoelectronics.com)