

Curve magnetiche / Magnetic curves / Magnet Kurven

880-881 Rm500



pag. 54

880-881 Rm500



pag. 55

880-881 Rm500



pag. 56

880-881 Rm500



pag. 57

880-881 Rm750



pag. 58

880-881 Rm750



pag. 59

880-881 Rm750



pag. 60

880-881 Rm860



pag. 61

880-881
K450 - Rm500



pag. 62

880-881
K450 - Rm610



pag. 63

880-881
K750 - Rm610



pag. 64

880-881
K750 - Rm860/750/1000



pag. 65

882-8857
K750 - Rm610



pag. 66

882-8857
K750 - Rm750



pag. 67

882-8857
K750 - Rm860



pag. 68

882-8857
K750 - Rm1000



pag. 69

882-8857
K1000 - Rm860



pag. 70

882-8857
K1200 - Rm860



pag. 71

LBP 882
K750 - Rm860



pag. 72

LBP 882
K1000 - Rm860



pag. 73

LBP 882
K1200 - Rm860



pag. 74

250M-260M



pag. 75

251M



pag. 76

Curve Tab / Tab curves / Tab Kurven

880-881
K325 - K450 - K750



pag. 77

882
K750 - K1000 - K1200



pag. 78

tab & magnetic corner tracks

Curva Larghezza Base = 100 mm; Passo = 85 mm / Curve Basic Width = 100 mm; Pitch = 85 mm / Kurve Basisbreite = 100 mm; Teilung = 85 mm

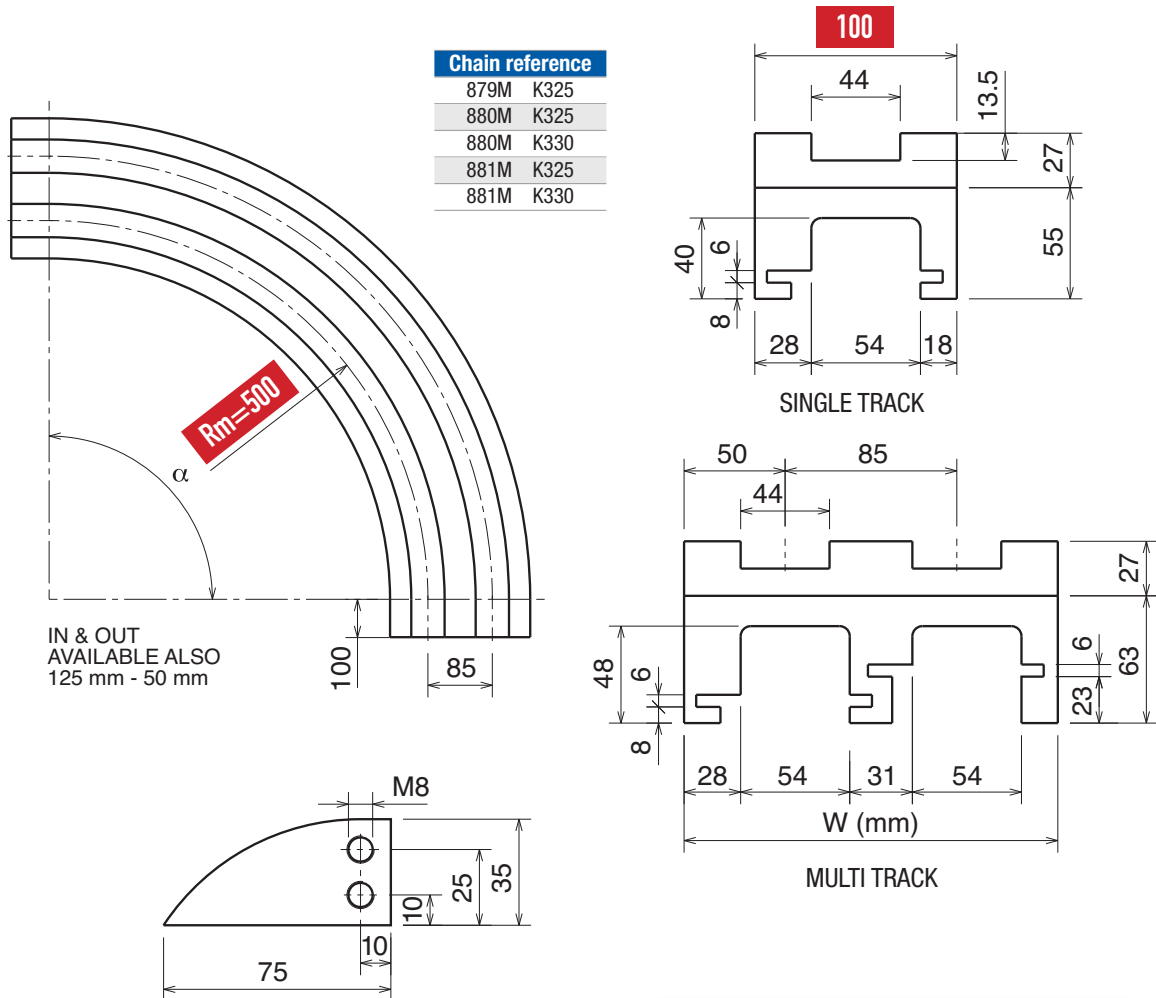

Magnetic System

Upper part available, on request, also in **BluLub**  and for abrasive applications.

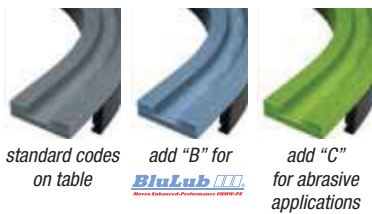

Part	$\alpha 15^\circ$	$\alpha 30^\circ$	$\alpha 45^\circ$	$\alpha 60^\circ$	$\alpha 75^\circ$	$\alpha 90^\circ$	Tracks	W
701	70111114	70111214	70111314	70111414	70111514	70111614	1	100
701	70111124	70111224	70111324	70111424	70111524	70111624	2	185
701	70111134	70111234	70111334	70111434	70111534	70111634	3	270
701	70111144	70111244	70111344	70111444	70111544	70111644	4	355
701	70111154	70111254	70111354	70111454	70111554	70111654	5	440
701	70111164	70111264	70111364	70111464	70111564	70111664	6	525
701	70111174	70111274	70111374	70111474	70111574	70111674	7	610
701	70111184	70111284	70111384	70111484	70111584	70111684	8	695

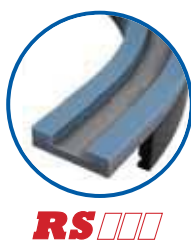

Part	$\alpha 15^\circ$	$\alpha 30^\circ$	$\alpha 45^\circ$	$\alpha 60^\circ$	$\alpha 75^\circ$	$\alpha 90^\circ$	Tracks	W
701	7011114RS	70111214RS	70111314RS	70111414RS	70111514RS	70111614RS	1	100
701	70111124RS	70111224RS	70111324RS	70111424RS	70111524RS	70111624RS	2	185
701	70111134RS	70111234RS	70111334RS	70111434RS	70111534RS	70111634RS	3	270
701	70111144RS	70111244RS	70111344RS	70111444RS	70111544RS	70111644RS	4	355
701	70111154RS	70111254RS	70111354RS	70111454RS	70111554RS	70111654RS	5	440
701	70111164RS	70111264RS	70111364RS	70111464RS	70111564RS	70111664RS	6	525
701	70111174RS	70111274RS	70111374RS	70111474RS	70111574RS	70111674RS	7	610
701	70111184RS	70111284RS	70111384RS	70111484RS	70111584RS	70111684RS	8	695

Materiale:	Material:	Materialien:
Polietilene UHMW-PE	Polyethylene UHMW-PE	Polyäthylen UHMW-PE

Curva Larghezza Base = 100 mm; Passo = 85 mm / Curve Basic Width = 100 mm; Pitch = 85 mm / Kurve Basisbreite = 100 mm; Teilung = 85 mm

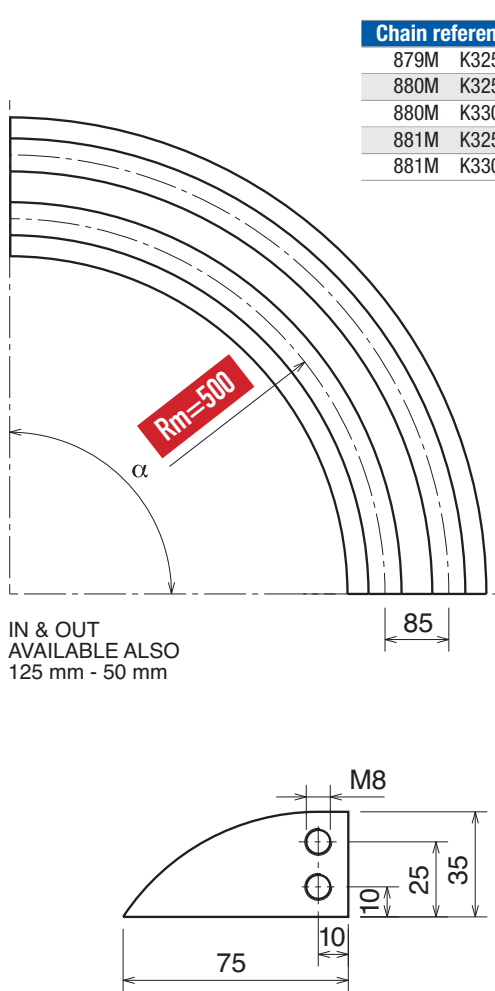

Chain reference	
879M	K325
880M	K325
880M	K330
881M	K325
881M	K330

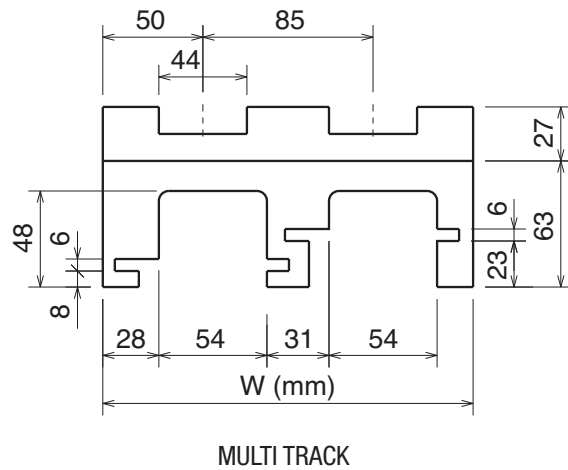
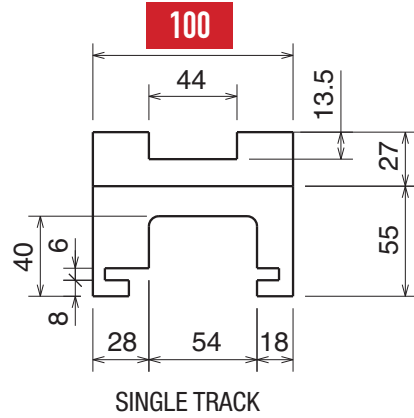

MOVEX Magnetic System

Upper part available, on request, also in **BluLub** and for abrasive applications.

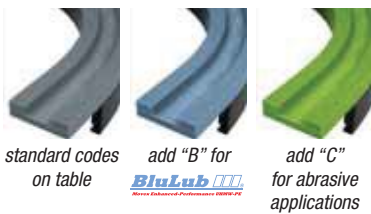

Part	$\alpha 15^\circ$	$\alpha 30^\circ$	$\alpha 45^\circ$	$\alpha 60^\circ$	$\alpha 75^\circ$	$\alpha 90^\circ$	Tracks	W
701	70111110	70111210	70111310	70111410	70111510	70111610	1	100
701	70111120	70111220	70111320	70111420	70111520	70111620	2	185
701	70111130	70111230	70111330	70111430	70111530	70111630	3	270
701	70111140	70111240	70111340	70111440	70111540	70111640	4	355
701	70111150	70111250	70111350	70111450	70111550	70111650	5	440
701	70111160	70111260	70111360	70111460	70111560	70111660	6	525
701	70111170	70111270	70111370	70111470	70111570	70111670	7	610
701	70111180	70111280	70111380	70111480	70111580	70111680	8	695

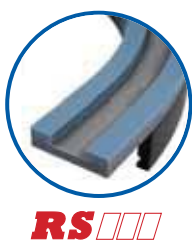

Part	$\alpha 15^\circ$	$\alpha 30^\circ$	$\alpha 45^\circ$	$\alpha 60^\circ$	$\alpha 75^\circ$	$\alpha 90^\circ$	Tracks	W
701	70111110RS	70111210RS	70111310RS	70111410RS	70111510RS	70111610RS	1	100
701	70111120RS	70111220RS	70111320RS	70111420RS	70111520RS	70111620RS	2	185
701	70111130RS	70111230RS	70111330RS	70111430RS	70111530RS	70111630RS	3	270
701	70111140RS	70111240RS	70111340RS	70111440RS	70111540RS	70111640RS	4	355
701	70111150RS	70111250RS	70111350RS	70111450RS	70111550RS	70111650RS	5	440
701	70111160RS	70111260RS	70111360RS	70111460RS	70111560RS	70111660RS	6	525
701	70111170RS	70111270RS	70111370RS	70111470RS	70111570RS	70111670RS	7	610
701	70111180RS	70111280RS	70111380RS	70111480RS	70111580RS	70111680RS	8	695

Curva Larghezza Base = 110 mm; Passo = 85 mm / Curve Basic Width = 110 mm; Pitch = 85 mm / Kurve Basisbreite = 110 mm; Teilung = 85 mm

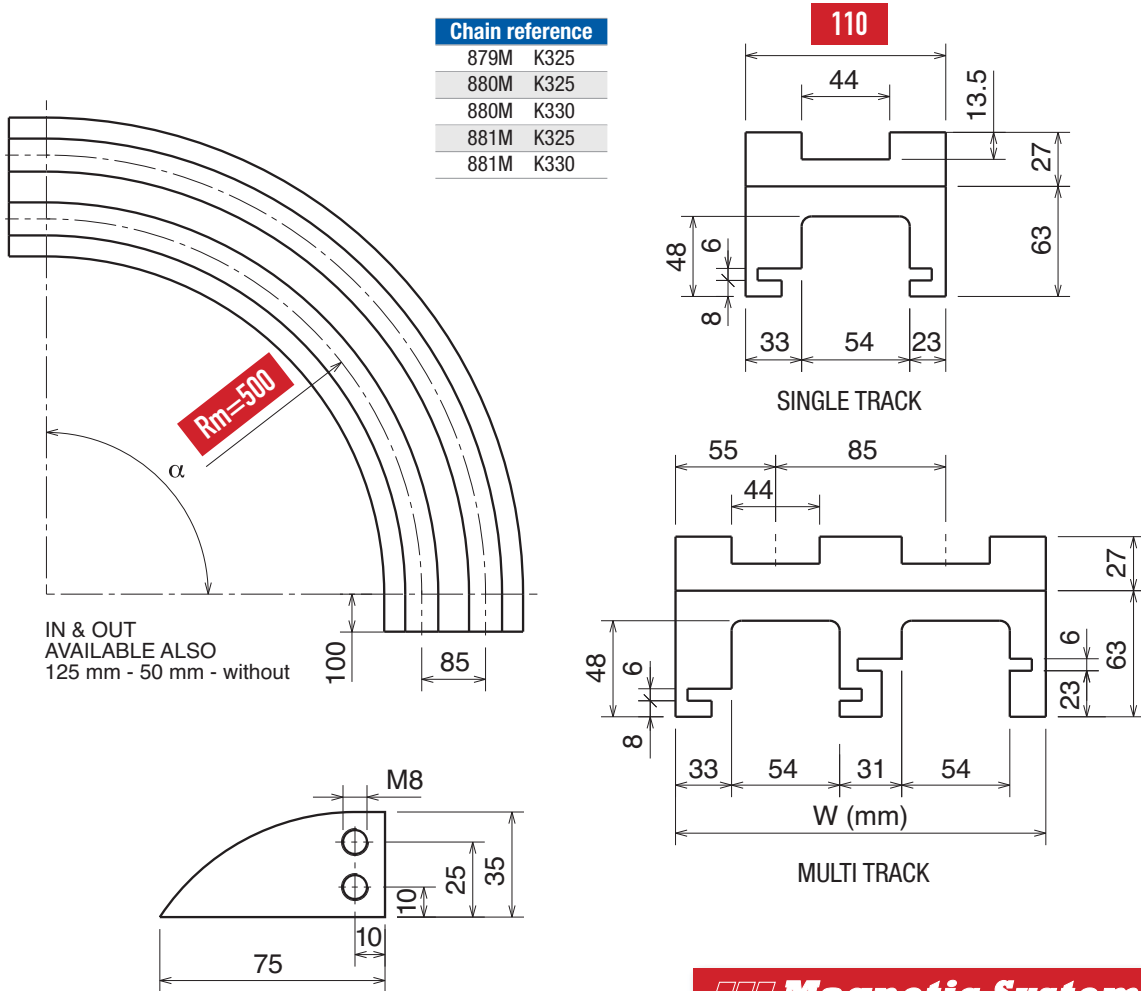

Chain reference	
879M	K325
880M	K325
880M	K330
881M	K325
881M	K330

Magnetic System

Upper part available, on request, also in **BluLub ** Movex Enhanced-Performance UHMW-PE and for abrasive applications.

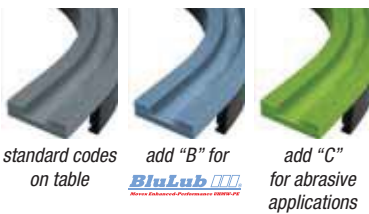

Part	α 15°	α 30°	α 45°	α 60°	α 75°	α 90°	Tracks	W
711	71111114	71111214	71111314	71111414	71111514	71111614	1	110
711	71111124	71111224	71111324	71111424	71111524	71111624	2	195
711	71111134	71111234	71111334	71111434	71111534	71111634	3	280
711	71111144	71111244	71111344	71111444	71111544	71111644	4	365
711	71111154	71111254	71111354	71111454	71111554	71111654	5	450
711	71111164	71111264	71111364	71111464	71111564	71111664	6	535
711	71111174	71111274	71111374	71111474	71111574	71111674	7	620
711	71111184	71111284	71111384	71111484	71111584	71111684	8	705

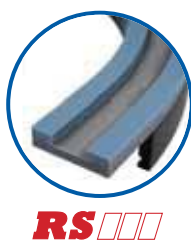

Part	α 15°	α 30°	α 45°	α 60°	α 75°	α 90°	Tracks	W
711	71111114RS	71111214RS	71111314RS	71111414RS	71111514RS	71111614RS	1	110
711	71111124RS	71111224RS	71111324RS	71111424RS	71111524RS	71111624RS	2	195
711	71111134RS	71111234RS	71111334RS	71111434RS	71111534RS	71111634RS	3	280
711	71111144RS	71111244RS	71111344RS	71111444RS	71111544RS	71111644RS	4	365
711	71111154RS	71111254RS	71111354RS	71111454RS	71111554RS	71111654RS	5	450
711	71111164RS	71111264RS	71111364RS	71111464RS	71111564RS	71111664RS	6	535
711	71111174RS	71111274RS	71111374RS	71111474RS	71111574RS	71111674RS	7	620
711	71111184RS	71111284RS	71111384RS	71111484RS	71111584RS	71111684RS	8	705

Materiale: Polietilene UHMW-PE Material: Polyethylene UHMW-PE Materialien: Polyäthylen UHMW-PE

Curva Larghezza Base = 111 mm; Passo = 85 mm / Curve Basic Width = 111 mm; Pitch = 85 mm / Kurve Basisbreite = 111 mm; Teilung = 85 mm

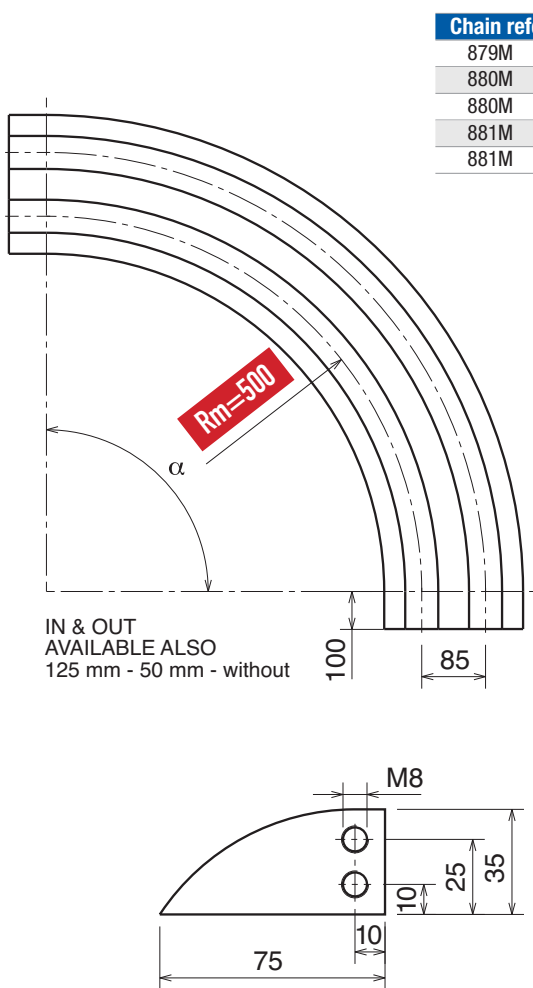

Chain reference	
879M	K325
880M	K325
880M	K330
881M	K325
881M	K330

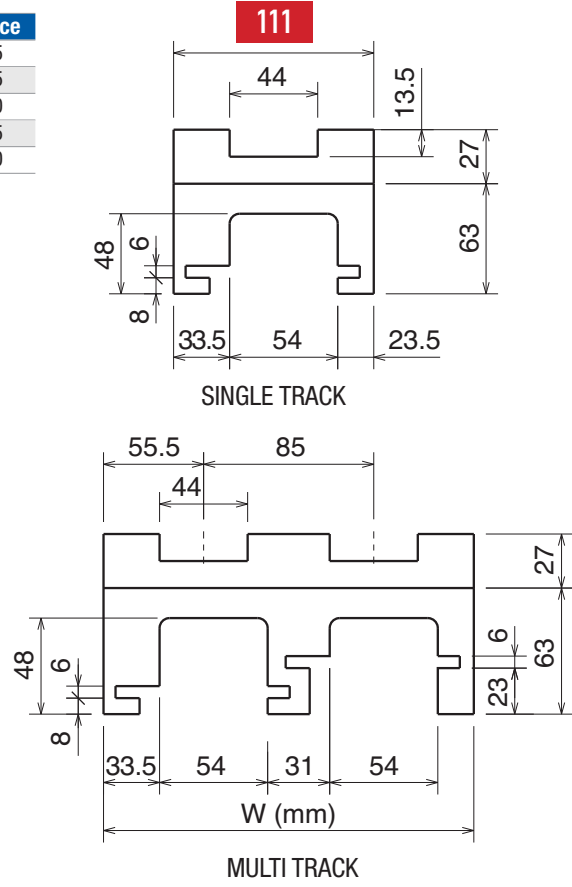

▣▣▣ Magnetic System

Upper part available, on request, also in **BluLub** Movex Enhanced-Performance UHMW-PE and for abrasive applications.

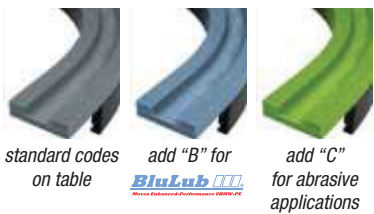

Part	α 15°	α 30°	α 45°	α 60°	α 75°	α 90°	Tracks	W
712	71211114	71211214	71211314	71211414	71211514	71211614	1	111
712	71211124	71211224	71211324	71211424	71211524	71211624	2	196
712	71211134	71211234	71211334	71211434	71211534	71211634	3	281
712	71211144	71211244	71211344	71211444	71211544	71211644	4	366
712	71211154	71211254	71211354	71211454	71211554	71211654	5	451
712	71211164	71211264	71211364	71211464	71211564	71211664	6	536
712	71211174	71211274	71211374	71211474	71211574	71211674	7	621
712	71211184	71211284	71211384	71211484	71211584	71211684	8	706

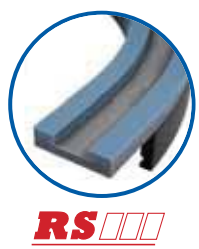

Part	α 15°	α 30°	α 45°	α 60°	α 75°	α 90°	Tracks	W
712	7121114RS	71211214RS	71211314RS	71211414RS	71211514RS	71211614RS	1	111
712	71211124RS	71211224RS	71211324RS	71211424RS	71211524RS	71211624RS	2	196
712	71211134RS	71211234RS	71211334RS	71211434RS	71211534RS	71211634RS	3	281
712	71211144RS	71211244RS	71211344RS	71211444RS	71211544RS	71211644RS	4	366
712	71211154RS	71211254RS	71211354RS	71211454RS	71211554RS	71211654RS	5	451
712	71211164RS	71211264RS	71211364RS	71211464RS	71211564RS	71211664RS	6	536
712	71211174RS	71211274RS	71211374RS	71211474RS	71211574RS	71211674RS	7	621
712	71211184RS	71211284RS	71211384RS	71211484RS	71211584RS	71211684RS	8	706

Curva Larghezza Base = 100 mm; Passo = 85 mm / Curve Basic Width = 100 mm; Pitch = 85 mm / Kurve Basisbreite = 100 mm; Teilung = 85 mm

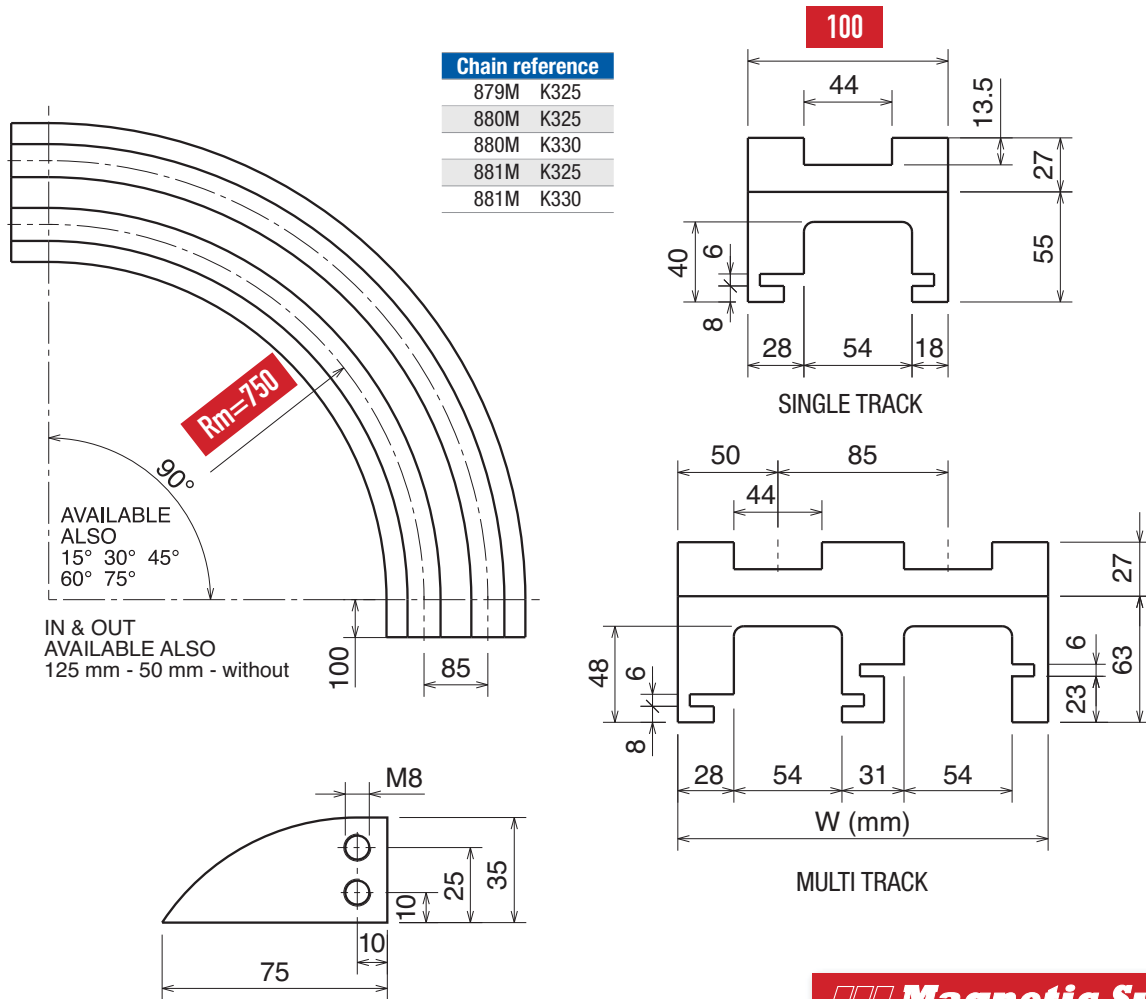

Chain reference	
879M	K325
880M	K325
880M	K330
881M	K325
881M	K330

Magnetic System

Upper part available, on request,
also in **BluLub** 
Movex Enhanced-Performance UHMW-PE
and for abrasive applications.

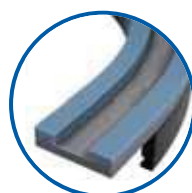

RS 

Part	Article-Nr.	Tracks	W
702	70216614	1	100
702	70216624	2	185
702	70216634	3	270
702	70216644	4	355
702	70216654	5	440
702	70216664	6	525
702	70216674	7	610
702	70216684	8	695

Part	Article-Nr.	Tracks	W
702	70216614RS	1	100
702	70216624RS	2	185
702	70216634RS	3	270
702	70216644RS	4	355
702	70216654RS	5	440
702	70216664RS	6	525
702	70216674RS	7	610
702	70216684RS	8	695

Materiale:	Material:	Materialien:
Polietilene UHMW-PE	Polyethylene UHMW-PE	Polyäthylen UHMW-PE

Curva Larghezza Base = 111 mm; Passo = 85 mm / Curve Basic Width = 111 mm; Pitch = 85 mm / Kurve Basisbreite = 111 mm; Teilung = 85 mm

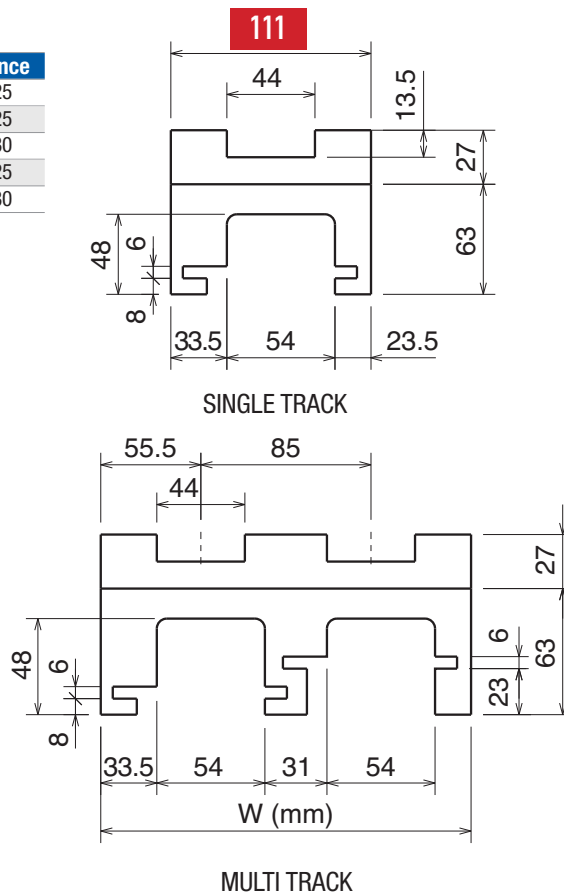
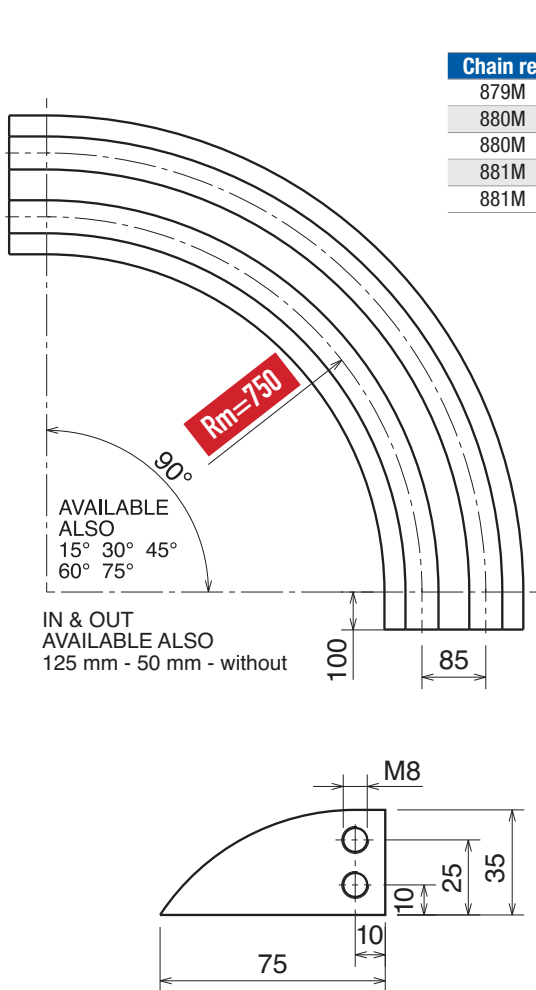

□□ Magnetic System

Upper part available, on request,
also in **BluLub** Movex Enhanced-Performance UHMW-PE
and for abrasive applications.

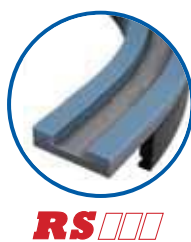
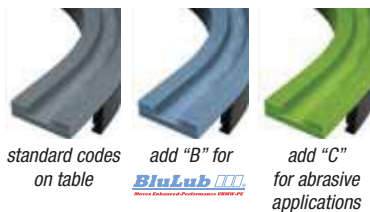

Part	Article-Nr.	Tracks	W
713	71316614	1	111
713	71316624	2	196
713	71316634	3	281
713	71316644	4	366
713	71316654	5	451
713	71316664	6	536
713	71316674	7	621
713	71316684	8	706

Part	Article-Nr.	Tracks	W
713	71316614RS	1	111
713	71316624RS	2	196
713	71316634RS	3	281
713	71316644RS	4	366
713	71316654RS	5	451
713	71316664RS	6	536
713	71316674RS	7	621
713	71316684RS	8	706

Curva Larghezza Base = 110 mm; Passo = 90 mm / Curve Basic Width = 110 mm; Pitch = 90 mm / Kurve Basisbreite = 110 mm; Teilung = 90 mm

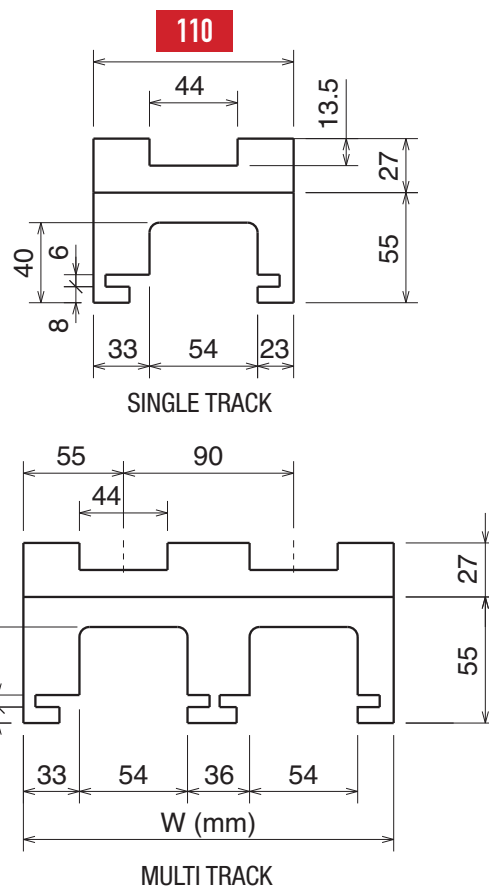
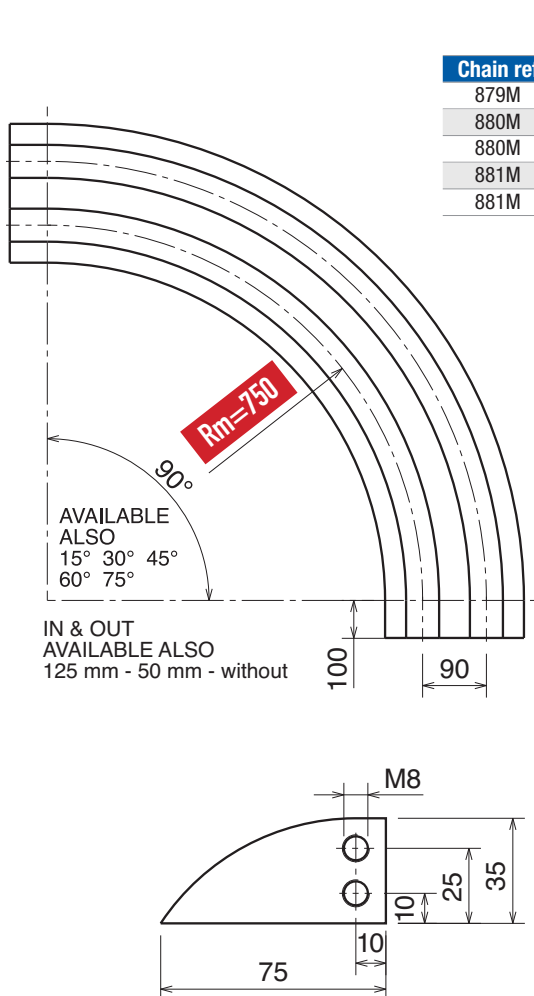

Magnetic System

Upper part available, on request, also in **BluLub**  and for abrasive applications.

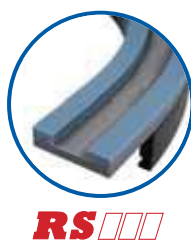
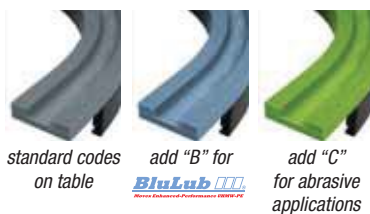

Part	Article-Nr.	Tracks	W
714	71416614	1	110
714	71416624	2	200
714	71416634	3	290
714	71416644	4	380
714	71416654	5	470
714	71416664	6	560
714	71416674	7	650
714	71416684	8	740

Part	Article-Nr.	Tracks	W
714	71416614RS	1	110
714	71416624RS	2	200
714	71416634RS	3	290
714	71416644RS	4	380
714	71416654RS	5	470
714	71416664RS	6	560
714	71416674RS	7	650
714	71416684RS	8	740

Materiale:	Material:	Materialien:
Polietilene UHMW-PE	Polyethylene UHMW-PE	Polyäthylen UHMW-PE

Curva Larghezza Base = 100 mm; Passo = 85 mm / Curve Basic Width = 100 mm; Pitch = 85 mm / Kurve Basisbreite = 100 mm; Teilung = 85 mm

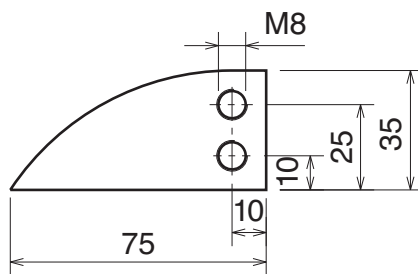
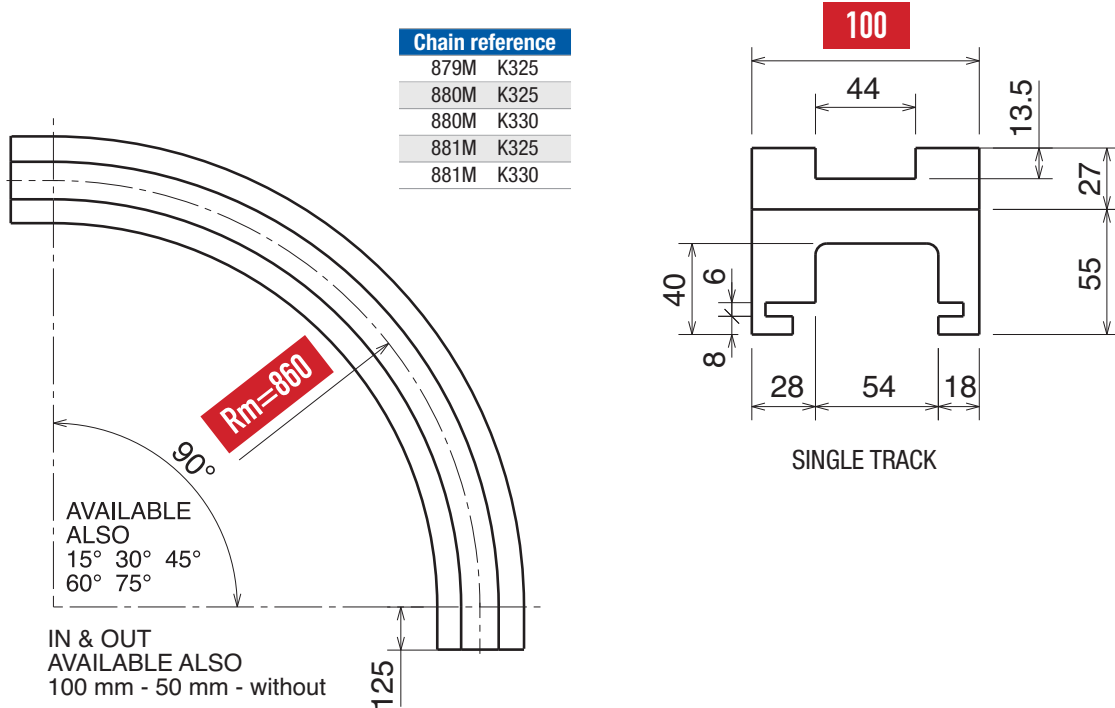

Upper part available, on request, also in **BluLub** Movex Enhanced-Performance UHMW-PE and for abrasive applications.

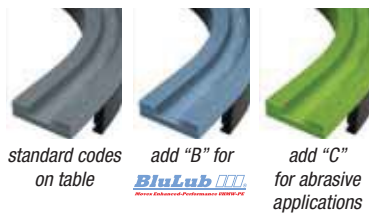

□□ Magnetic System

Part	Article-Nr.	Tracks	W
703	70318615	1	100

Part	Article-Nr.	Tracks	W
703	70318615RS	1	100

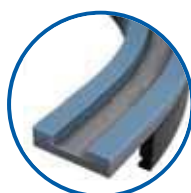

RS□□□

Curva Larghezza Base = 129 mm; Passo = 120 mm / Curve Basic Width = 129 mm; Pitch = 120 mm / Kurve Basisbreite = 129 mm; Teilung = 120 mm

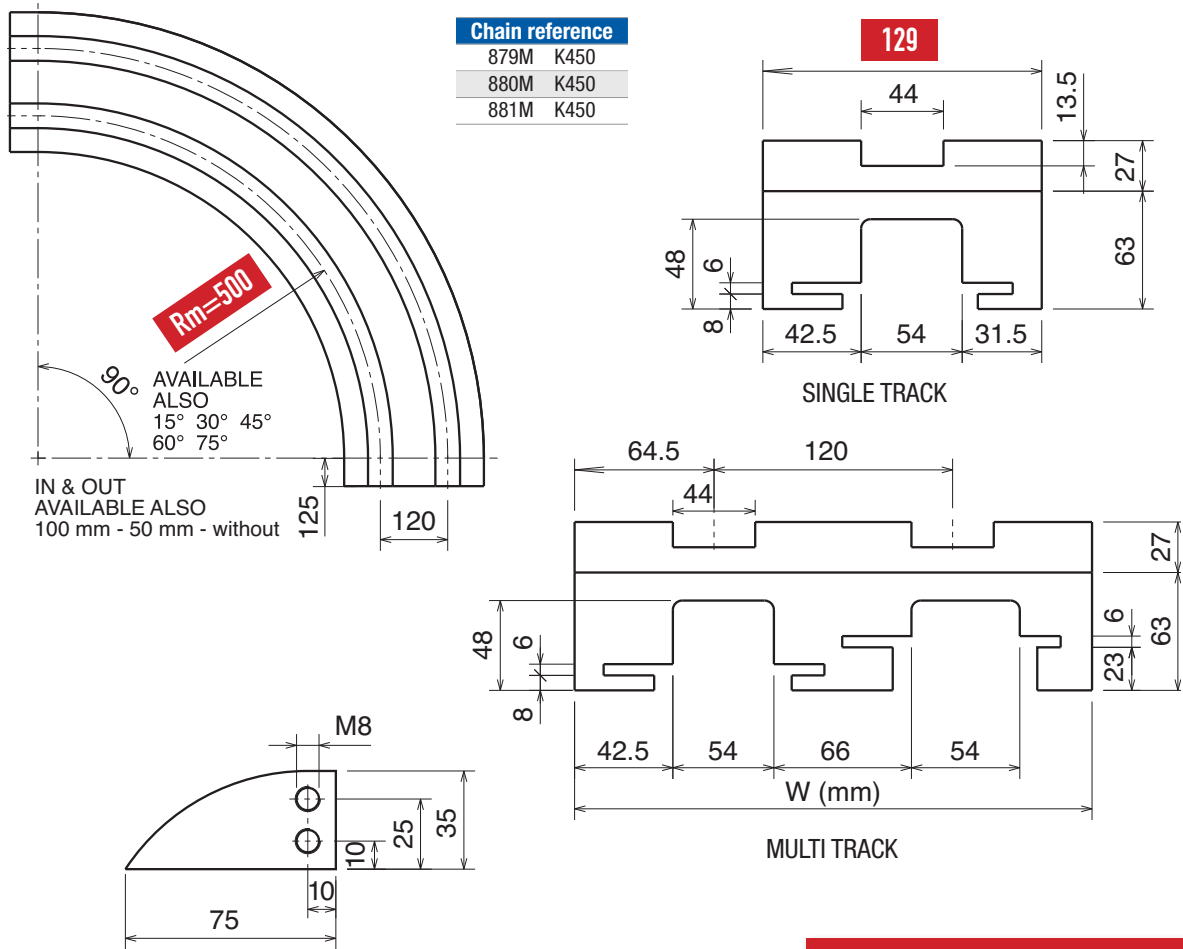

Chain reference	
879M	K450
880M	K450
881M	K450

Magnetic System

Upper part available, on request,
also in **BluLub** 
Movex Enhanced-Performance UHMW-PE
and for abrasive applications.

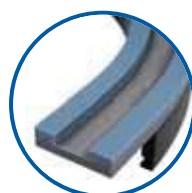
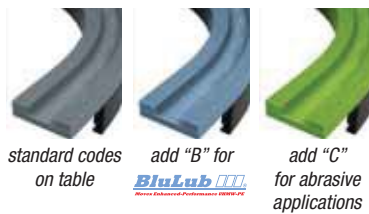

RS 

Part	Article-Nr.	Tracks	W
715	71511615	1	129
715	71511625	2	249
715	71511635	3	369
715	71511645	4	489
715	71511655	5	609

Part	Article-Nr.	Tracks	W
715	71511615RS	1	129
715	71511625RS	2	249
715	71511635RS	3	369
715	71511645RS	4	489
715	71511655RS	5	609

Materiale: Polietilene UHMW-PE
Material: Polyethylene UHMW-PE
Materialien: Polyäthylen UHMW-PE

Curva Larghezza Base = 129 mm; Passo = 120 mm / Curve Basic Width = 129 mm; Pitch = 120 mm / Kurve Basisbreite = 129 mm; Teilung = 120 mm

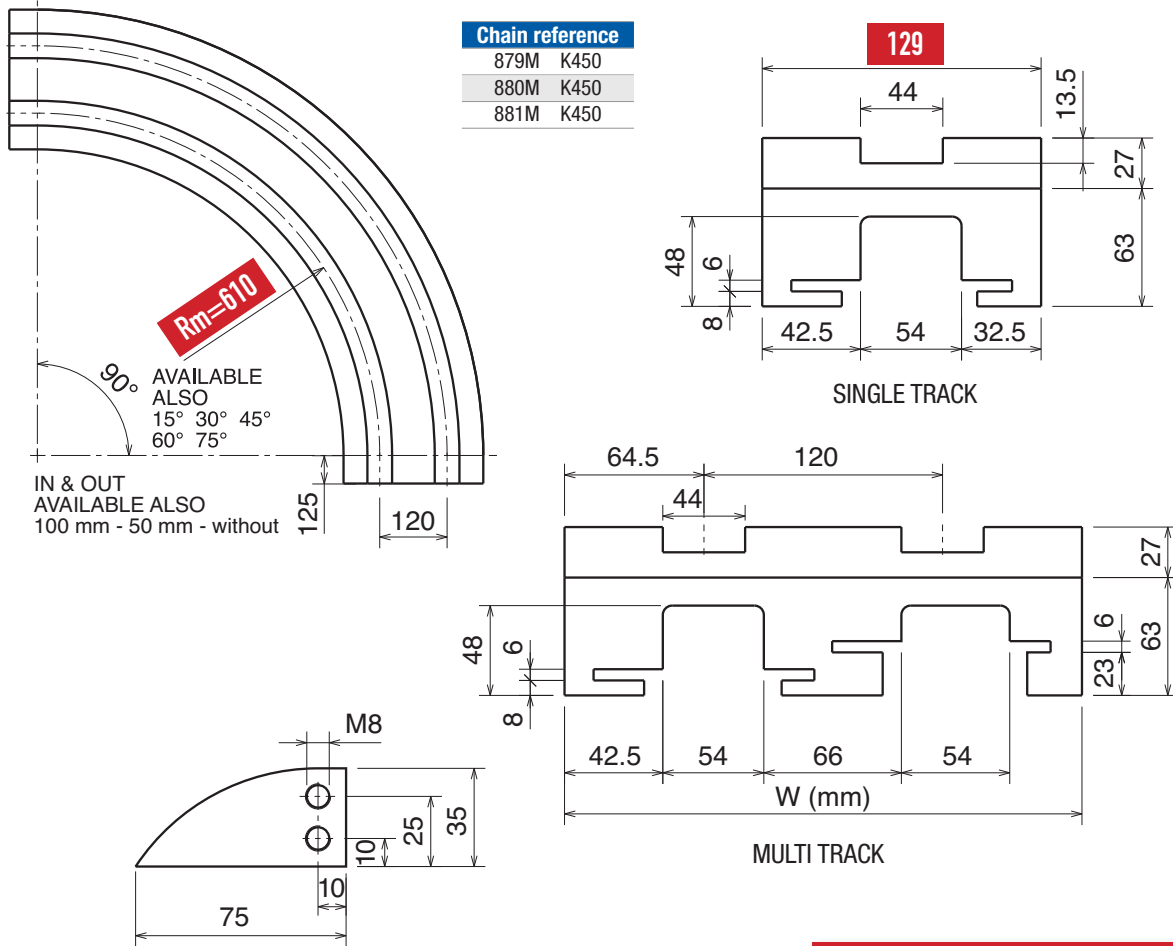

□□□ Magnetic System

Upper part available, on request, also in **BluLub** □□□
Movex Enhanced-Performance UHMW-PE
 and for abrasive applications.

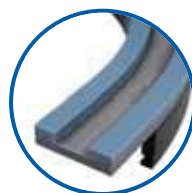
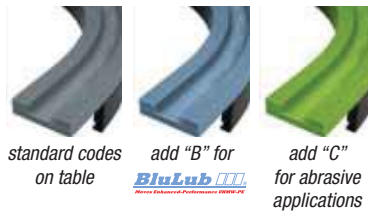

RS □□□

Part	Article-Nr.	Tracks	W
704	70413615	1	129
704	70413625	2	249
704	70413635	3	369
704	70413645	4	489
704	70413655	5	609

Part	Article-Nr.	Tracks	W
704	70413615RS	1	129
704	70413625RS	2	249
704	70413635RS	3	369
704	70413645RS	4	489
704	70413655RS	5	609

Curva Larghezza Base = 214 mm / Curve Basic Width = 214 mm / Kurve Basisbreite = 214 mm

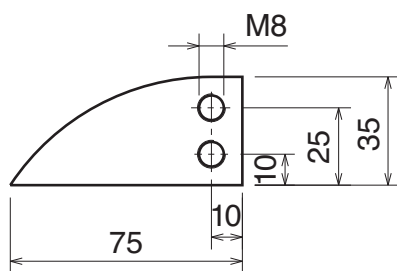
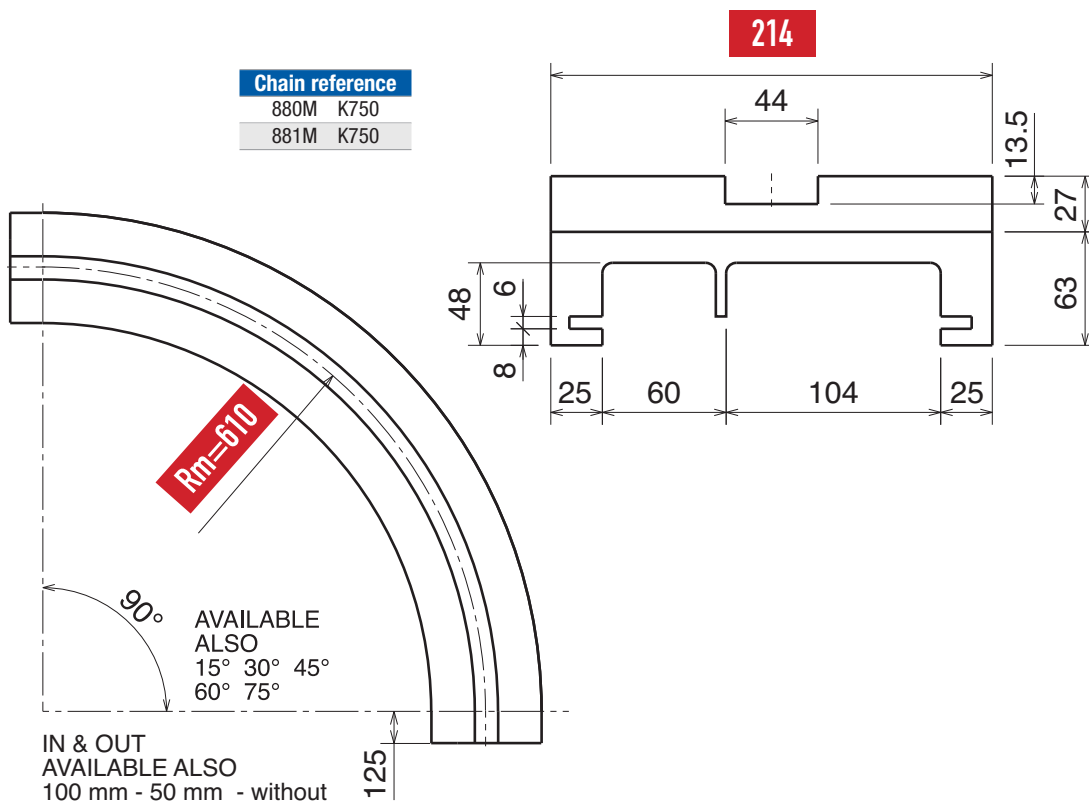

Magnetic System

Part	Article-Nr.	Tracks	W
716	71613615	1	214

Part	Article-Nr.	Tracks	W
716	71613615RS	1	214

Upper part available, on request, also in **BluLub**  Movex Enhanced-Performance UHMW-PE and for abrasive applications.



standard codes on table

add "B" for **BluLub**  Movex Enhanced-Performance UHMW-PE

add "C" for abrasive applications

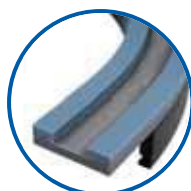

RS 

Curva Larghezza Base = 214 mm / Curve Basic Width = 214 mm / Kurve Basisbreite = 214 mm

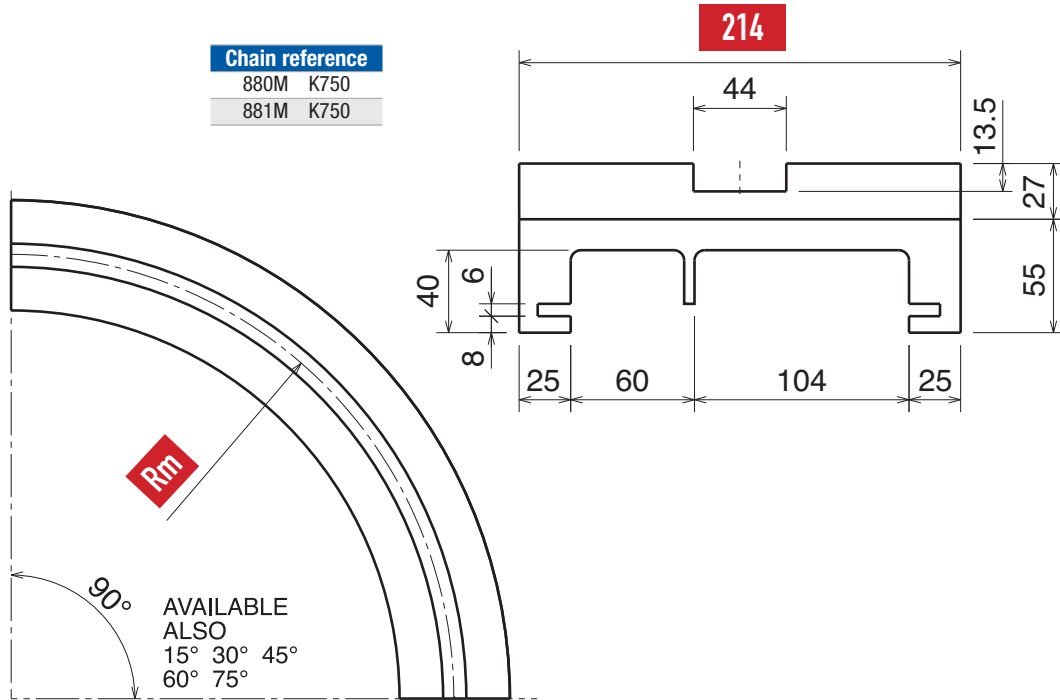

Chain reference
880M K750
881M K750

IN & OUT
AVAILABLE ALSO
125 mm - 100 mm - 50 mm

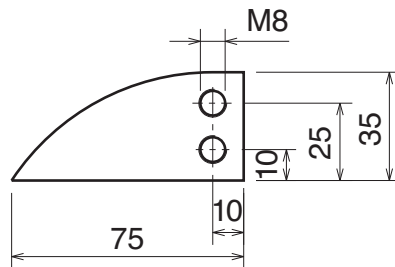

Magnetic System

Upper part available, on request,
also in **BluLub** Movex Enhanced-Performance UHMW-PE
and for abrasive applications.



standard codes on table add "B" for **BluLub** Movex Enhanced-Performance UHMW-PE add "C" for abrasive applications

Part	Article-Nr.	Tracks	W
707	70716610	1	214 750
707	70718610	1	214 860
707	70719610	1	214 1000

Part	Article-Nr.	Tracks	W
707	70716610RS	1	214 750
707	70718610RS	1	214 860
707	70719610RS	1	214 1000

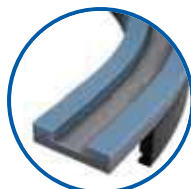

RS

Curva Larghezza Base = 200 mm / Curve Basic Width = 200 mm / Kurve Basisbreite = 200 mm

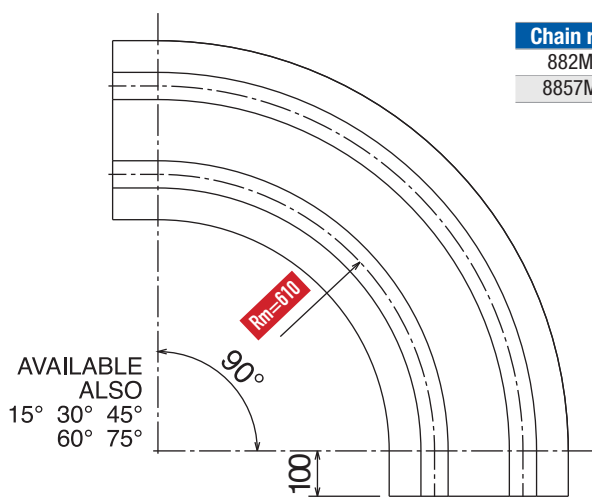

IN & OUT
AVAILABLE ALSO
125 mm - 100 mm - without

Chain reference
882M K750
8857M K750

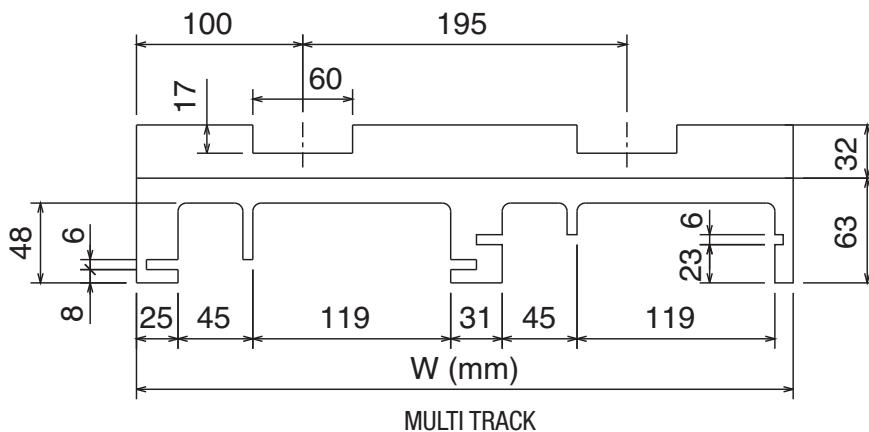
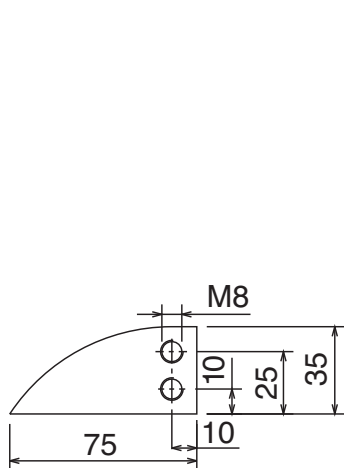
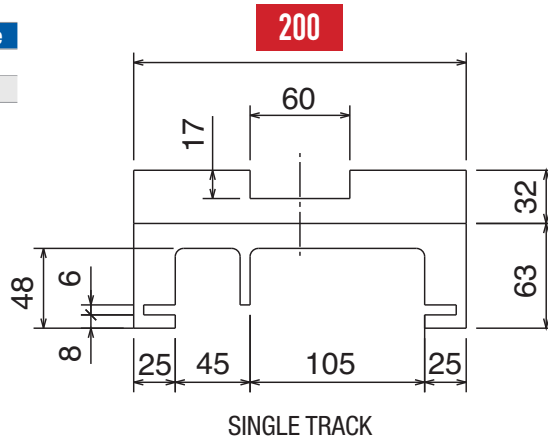

Magnetic System

Upper part available, on request,
also in **BluLub** M81
Movex Enhanced-Performance UHMW-PE
and for abrasive applications.

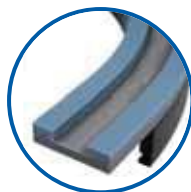

RS M81

Part	Article-Nr.	Tracks	W
717	71713614	1	200
717	71713624	2	395
717	71713634	3	590
717	71713644	4	785

Part	Article-Nr.	Tracks	W
717	71713614RS	1	200
717	71713624RS	2	395
717	71713634RS	3	590
717	71713644RS	4	785

Materiale:	Material:	Materialien:
Polietilene UHMW-PE	Polyethylene UHMW-PE	Polyäthylen UHMW-PE

Curva Larghezza Base = 200 mm / Curve Basic Width = 200 mm / Kurve Basisbreite = 200 mm

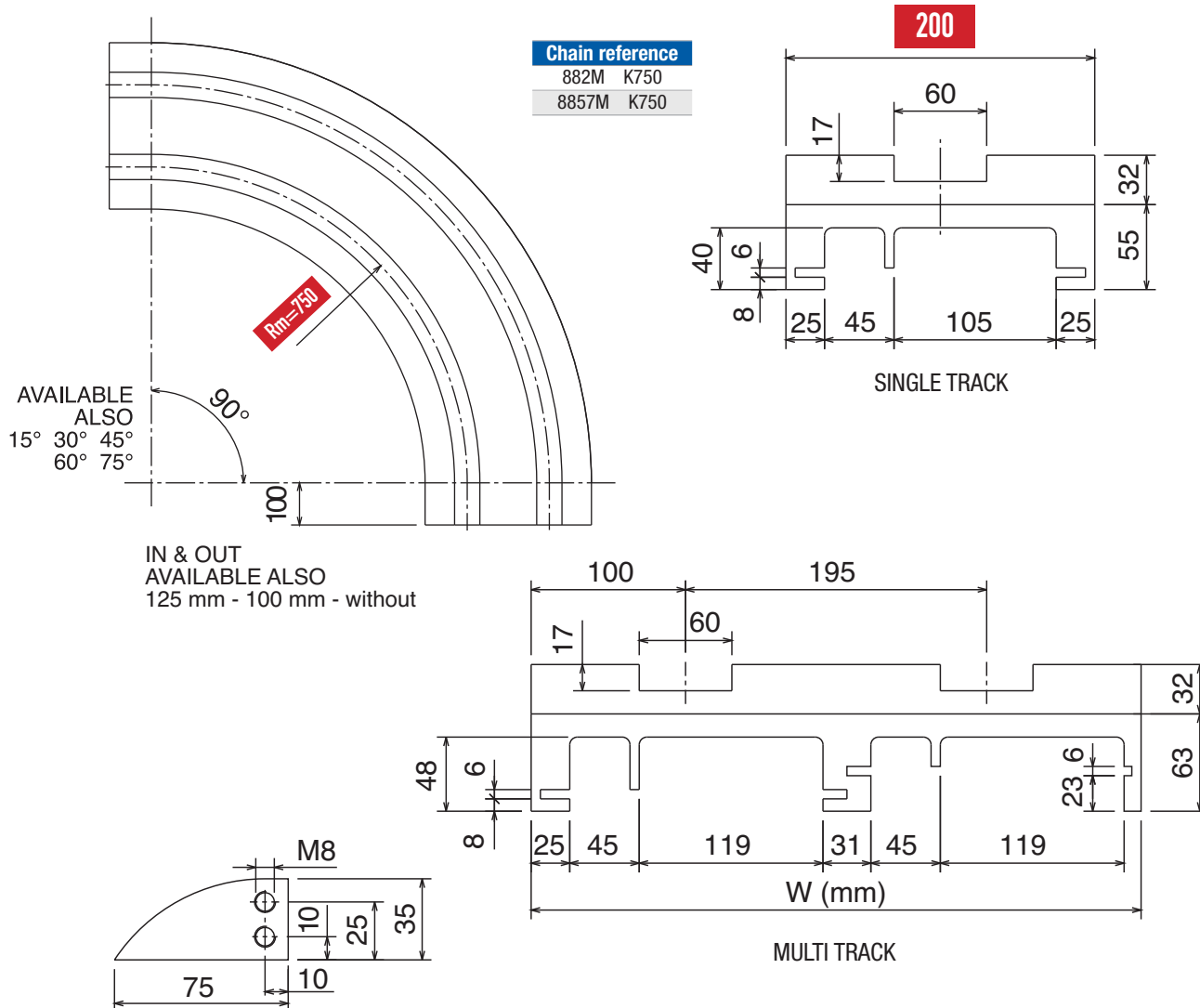

□□□ **Magnetic System**

Upper part available, on request, also in **BluLub** Movex Enhanced-Performance UHMW-PE and for abrasive applications.



standard codes on table add "B" for **BluLub** add "C" for abrasive applications

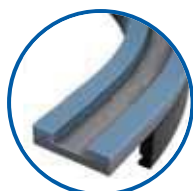

RS □□□

Part	Article-Nr.	Tracks	W
718	71816614	1	200
718	71816624	2	395
718	71816634	3	590

Part	Article-Nr.	Tracks	W
718	71816614RS	1	200
718	71816624RS	2	395
718	71816634RS	3	590

Curva Larghezza Base = 214 mm; Passo = 200 mm / Curve Basic Width = 214 mm; Pitch = 200 mm / Kurve Basisbreite = 214 mm; Teilung = 200 mm

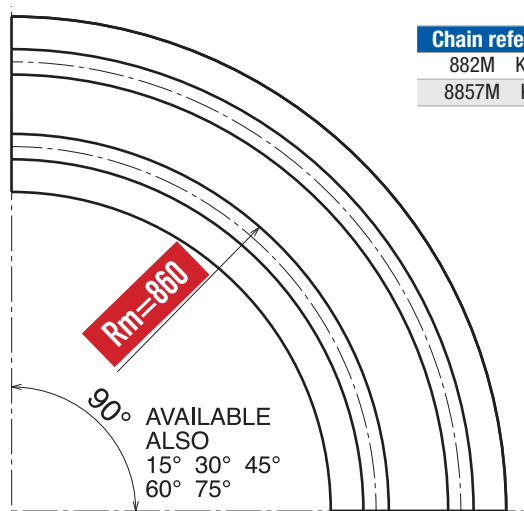

IN & OUT
AVAILABLE ALSO
125 mm
100 mm
50 mm

Chain reference	
882M	K750
8857M	K750

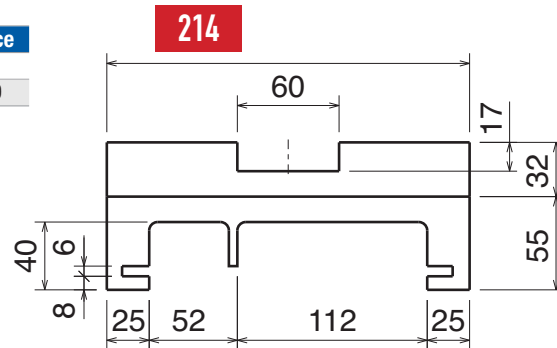

SINGLE TRACK

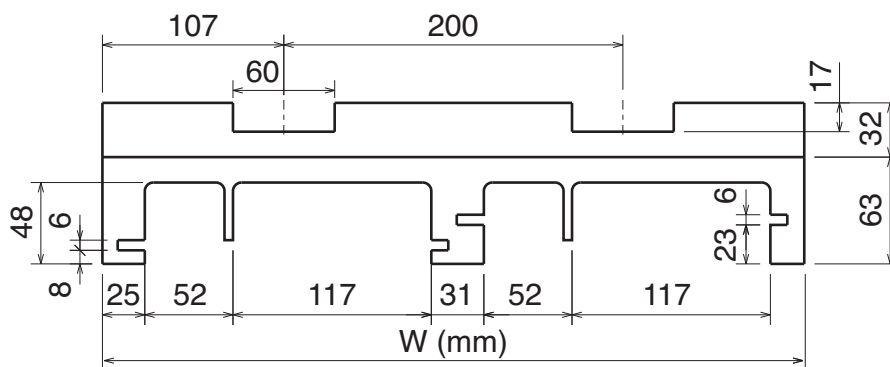

MULTI TRACK

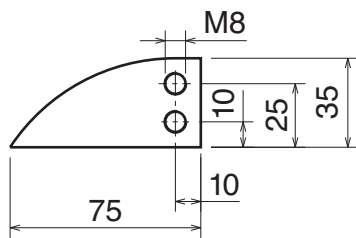

Magnetic System

Upper part available, on request,
also in **BluLub** M86
Movex Enhanced-Performance UHMW-PE
and for abrasive applications.



standard codes
on table

add "B" for
BluLub M86
Movex Enhanced-Performance UHMW-PE

add "C"
for abrasive
applications

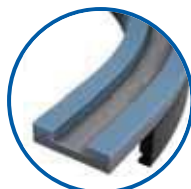

RS M86

Part	Article-Nr.	Tracks	W
708	70818610	1	214
708	70818620	2	410
708	70818630	3	606

Part	Article-Nr.	Tracks	W
708	70818610RS	1	214
708	70818620RS	2	410
708	70818630RS	3	606

Materiale:	Material:	Materialien:
Polietilene UHMW-PE	Polyethylene UHMW-PE	Polyäthylen UHMW-PE

Curva Larghezza Base = 200 mm / Curve Basic Width = 200 mm / Kurve Basisbreite = 200 mm

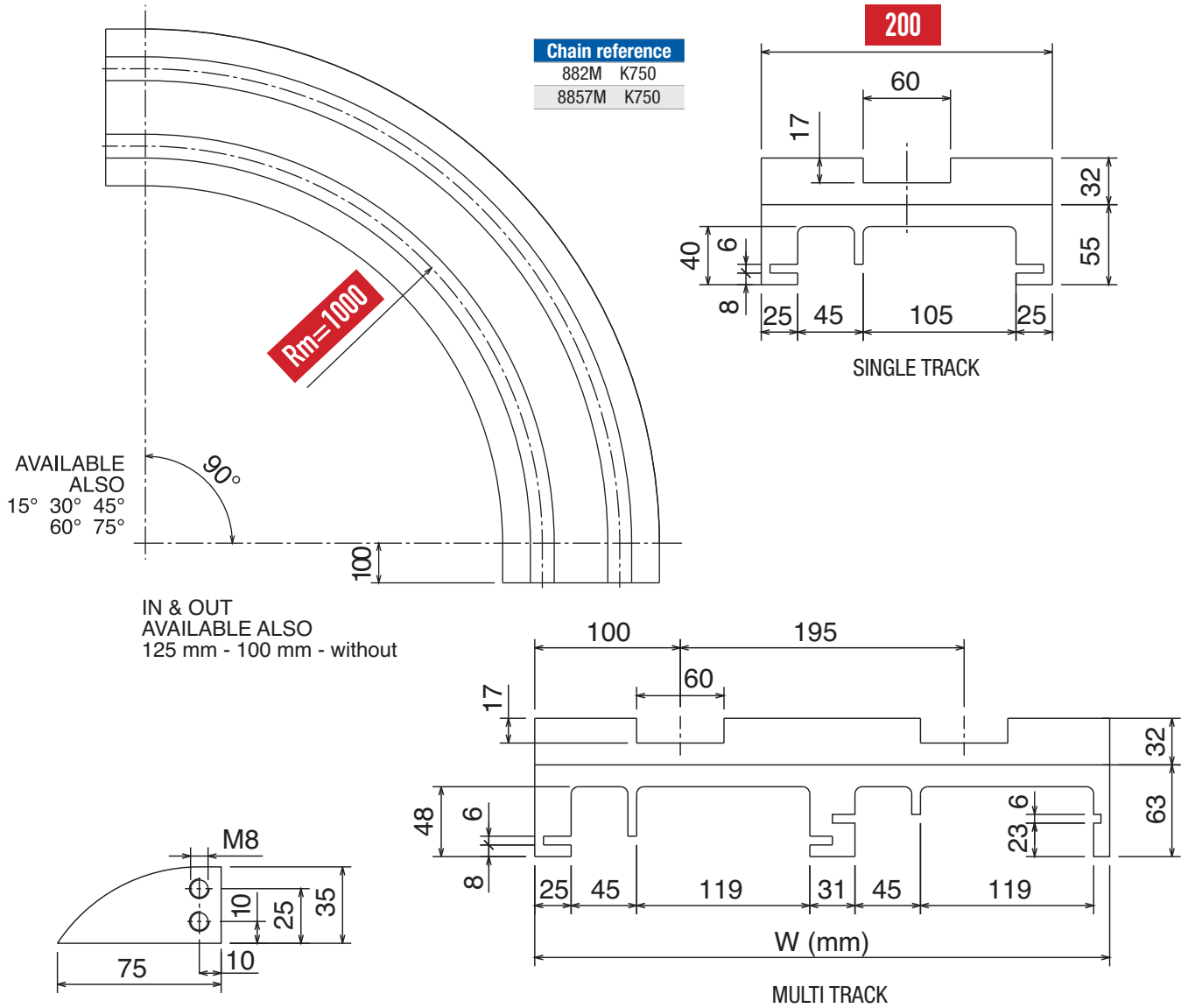

Upper part available, on request, also in **BluLub** Movex Enhanced-Performance UHMW-PE and for abrasive applications.

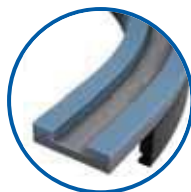
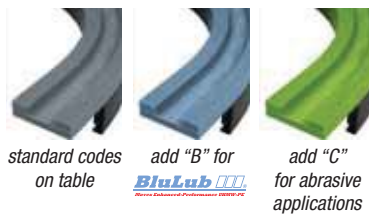

RS □□□

□□□ **Magnetic System**

Part	Article-Nr.	Tracks	W
719	71919614	1	200
719	71919624	2	395
719	71919634	3	590

Part	Article-Nr.	Tracks	W
719	71919614RS	1	200
719	71919624RS	2	395
719	71919634RS	3	590

Curva Larghezza Base = 270 mm / Curve Basic Width = 270 mm / Kurve Basisbreite = 270 mm

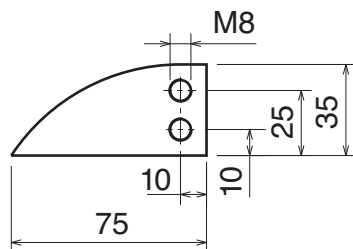
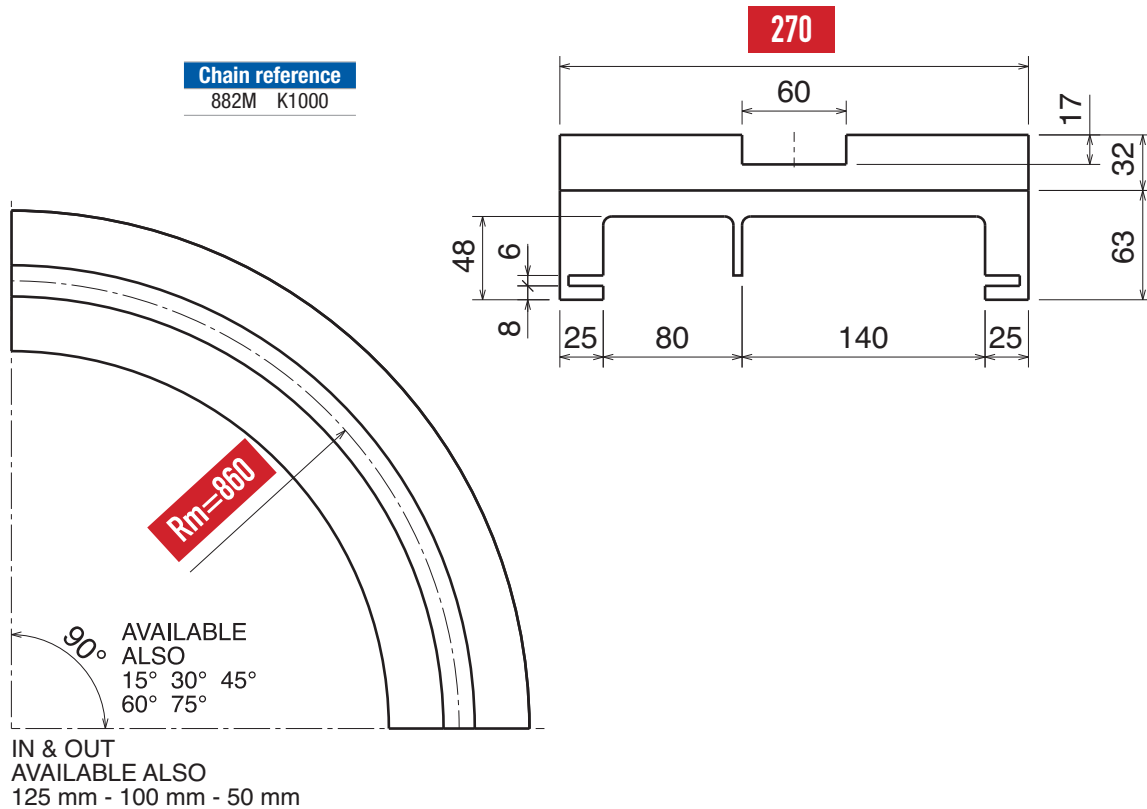

Magnetic System

Upper part available, on request, also in **BluLub ** Movex Enhanced-Performance UHMW-PE and for abrasive applications.



standard codes
on table

add "B" for
BluLub 

add "C"
for abrasive
applications

Part	Article-Nr.	Tracks	W
709	70918610	1	270

Part	Article-Nr.	Tracks	W
709	70918610RS	1	270

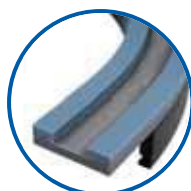

RS 

Curva Larghezza Base = 320 mm / Curve Basic Width = 320 mm / Kurve Basisbreite = 320 mm

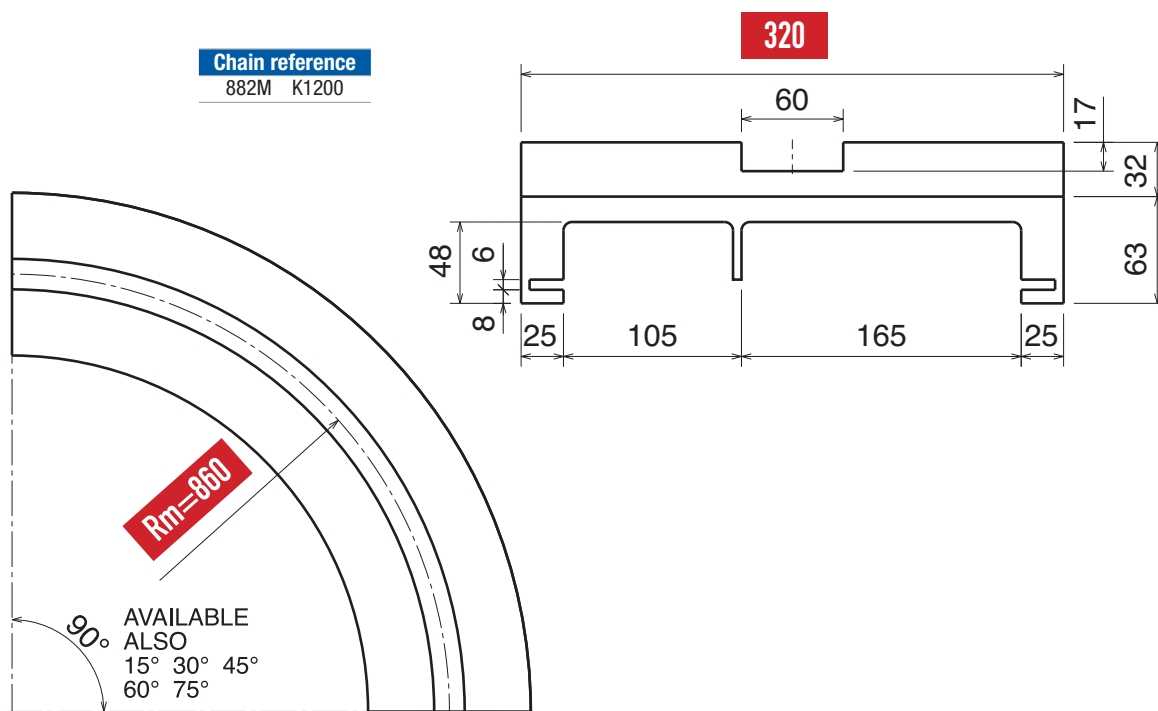

IN & OUT
AVAILABLE ALSO
125 mm - 100 mm - 50 mm

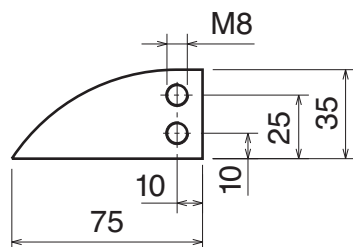

□□□ Magnetic System

Upper part available, on request,
also in **BluLub** □□□
Movex Enhanced-Performance UHMW-PE
and for abrasive applications.



standard codes
on table

add "B" for
BluLub □□□
Movex Enhanced-Performance UHMW-PE

add "C"
for abrasive
applications

Part	Article-Nr.	Tracks	W
710	71018610	1	320

Part	Article-Nr.	Tracks	W
710	71018610RS	1	320

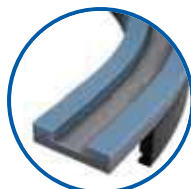

RS □□□

Curva Larghezza Base = 214 mm / Curve Basic Width = 214 mm / Kurve Basisbreite = 214 mm

Chain reference
LBP 882M K750

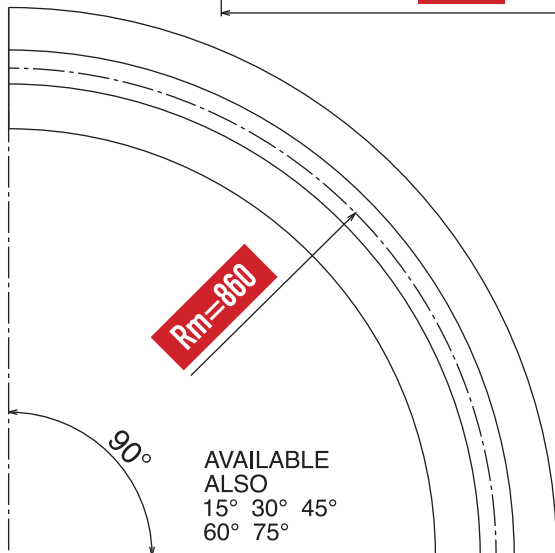
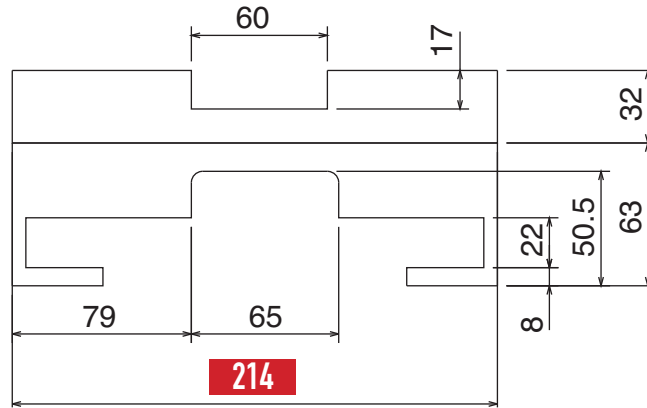

IN & OUT
AVAILABLE ALSO
125 mm - 100 mm - 50 mm

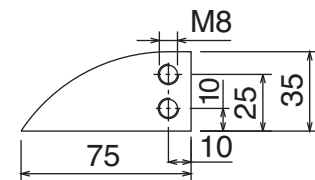

Magnetic System

Upper part available, on request, also in **BluLub** Movex Enhanced-Performance UHMW-PE and for abrasive applications.



standard codes
on table

add "B" for
BluLub

add "C"
for abrasive
applications

Part	Article-Nr.	Tracks	W
781	78118610	1	214

Part	Article-Nr.	Tracks	W
781	78118610RS	1	214

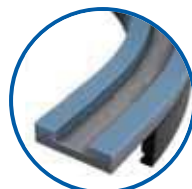

RS

Materiale: Polietilene UHMW-PE	Material: Polyethylene UHMW-PE	Materialien: Polyäthylen UHMW-PE
--	--	--

Curva Larghezza Base = 290 mm / Curve Basic Width = 290 mm / Kurve Basisbreite = 290 mm

Chain reference
LBP 882M K1000

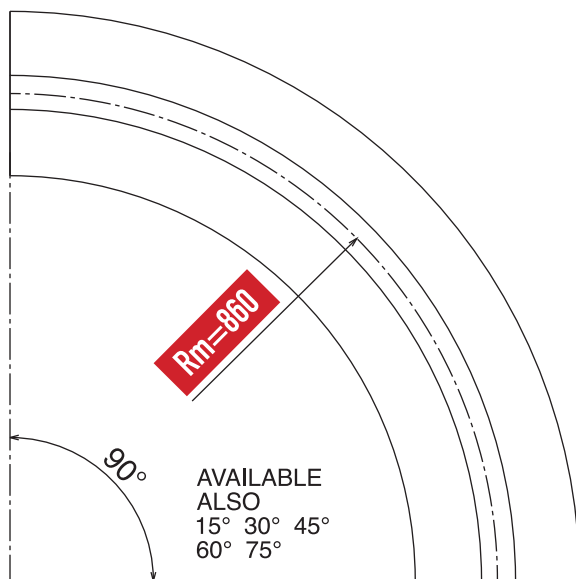
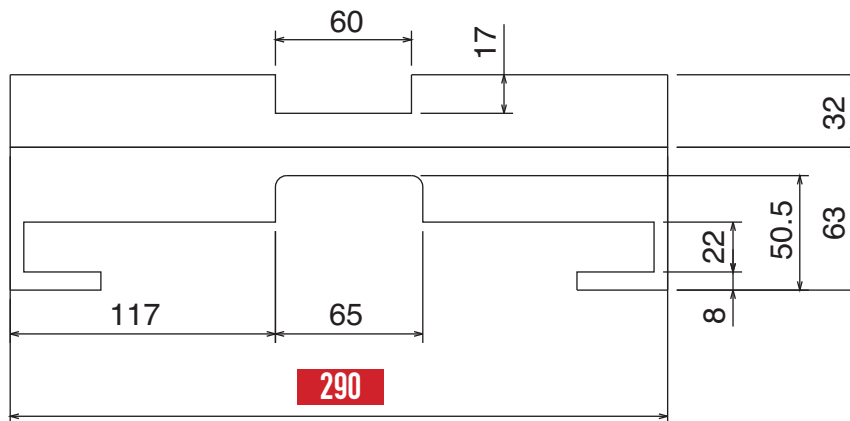

IN & OUT
AVAILABLE ALSO
125 mm - 100 mm - 50 mm

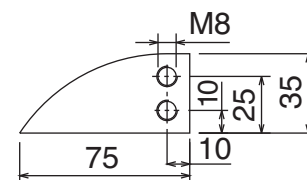

Magnetic System

Upper part available, on request,
also in **BluLub** 
Movex Enhanced-Performance UHMW-PE
and for abrasive applications.



standard codes
on table

add "B" for
BluLub 
Movex Enhanced-Performance UHMW-PE

add "C"
for abrasive
applications

Part	Article-Nr.	Tracks	W
782	78218610	1	290

Part	Article-Nr.	Tracks	W
782	78218610RS	1	290

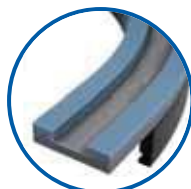

RS 

Curva Larghezza Base = 340 mm / Curve Basic Width = 340 mm / Kurve Basisbreite = 340 mm

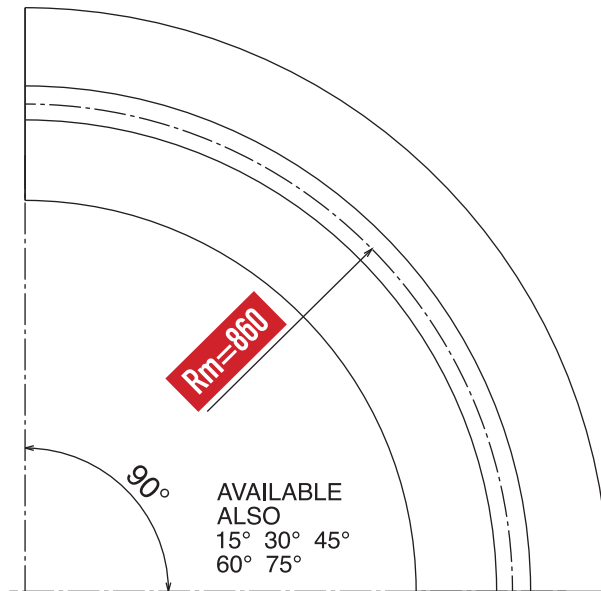
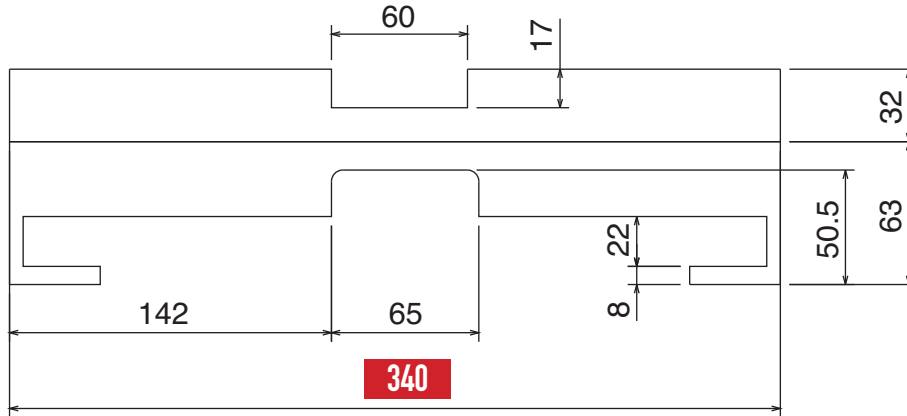

IN & OUT
AVAILABLE ALSO
125 mm - 100 mm - 50 mm

Chain reference
LBP 882M K1200

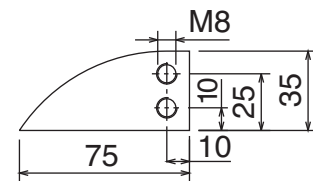

Magnetic System

Upper part available, on request,
also in **BluLub** MP96
Movex Enhanced-Performance UHMW-PE
and for abrasive applications.



standard codes on table add "B" for **BluLub** MP96 add "C" for abrasive applications

Part	Article-Nr.	Tracks	W
783	78318610	1	340

Part	Article-Nr.	Tracks	W
783	78318610RS	1	340

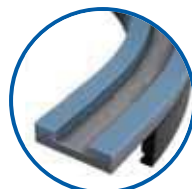

RS MP96

Curva Larghezza Base = 100 mm; Passo = 85 mm / Curve Basic Width = 100 mm; Pitch = 85 mm / Kurve Basisbreite = 100 mm; Teilung = 85 mm

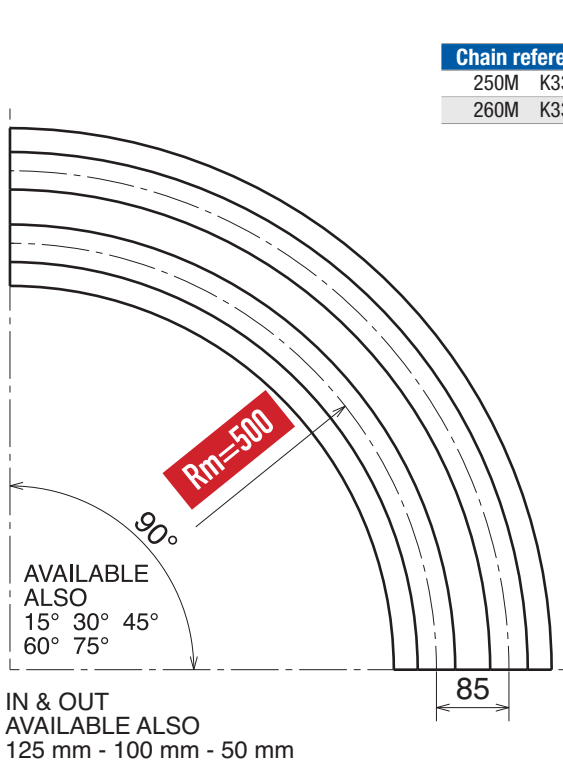

Chain reference

250M	K330
260M	K330

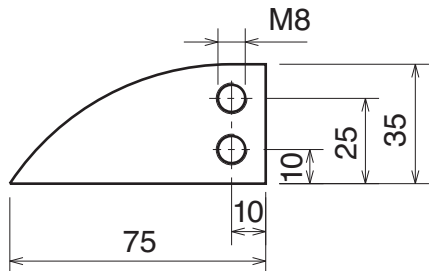
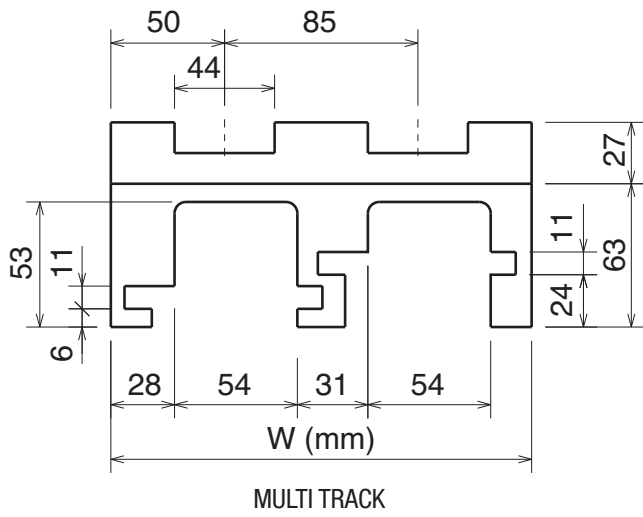
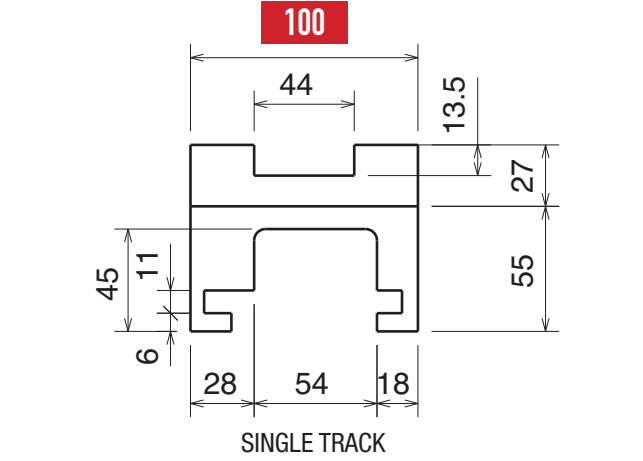

Magnetic System

Part	Article-Nr.	Tracks	W
705	70511610	1	100
705	70511620	2	185
705	70511630	3	270
705	70511640	4	355
705	70511650	5	440
705	70511660	6	525
705	70511670	7	610
705	70511680	8	695

Part	Article-Nr.	Tracks	W
705	70511610RS	1	100
705	70511620RS	2	185
705	70511630RS	3	270
705	70511640RS	4	355
705	70511650RS	5	440
705	70511660RS	6	525
705	70511670RS	7	610
705	70511680RS	8	695

Upper part available, on request, also in **BluLub** Movex Enhanced-Performance UHMW-PE and for abrasive applications.

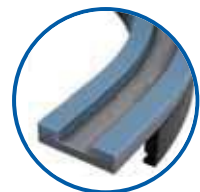
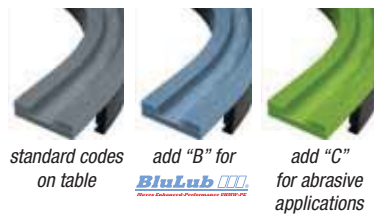

RS

Curva Larghezza Base = 100 mm; Passo = 85 mm / Curve Basic Width = 100 mm; Pitch = 85 mm / Kurve Basisbreite = 100 mm; Teilung = 85 mm

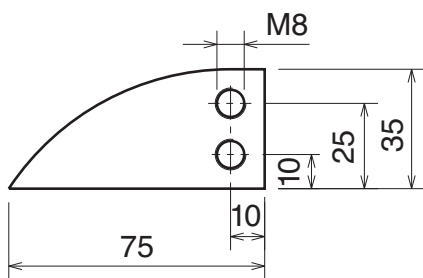
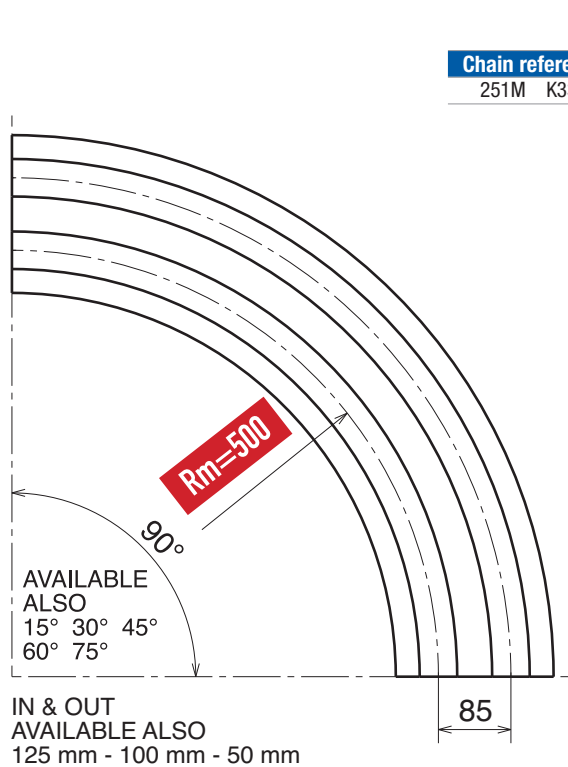

Chain reference
251M K330

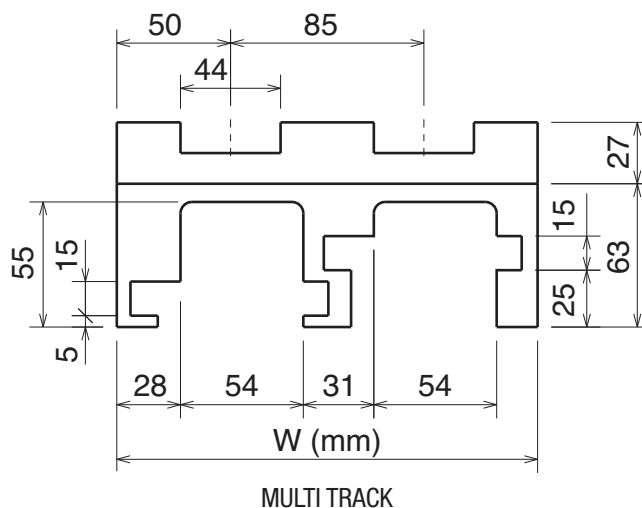
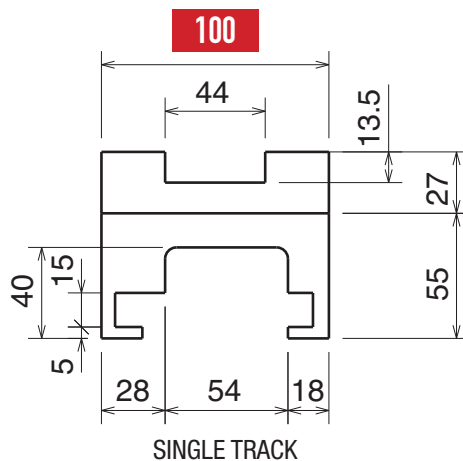

Magnetic System

Part	Article-Nr.	Tracks	W
706	70611610	1	100
706	70611620	2	185
706	70611630	3	270
706	70611640	4	355
706	70611650	5	440
706	70611660	6	525
706	70611670	7	610
706	70611680	8	695

Part	Article-Nr.	Tracks	W
706	70611610RS	1	100
706	70611620RS	2	185
706	70611630RS	3	270
706	70611640RS	4	355
706	70611650RS	5	440
706	70611660RS	6	525
706	70611670RS	7	610
706	70611680RS	8	695

Upper part available, on request, also in **BluLub**  Movex Enhanced-Performance UHMW-PE and for abrasive applications.

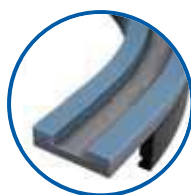

RS 

Curva 880-881 TAB K325-K450-K750 / Curve 880-881 TAB K325-K450-K750 / Kurve 880-881 TAB K325-K450-K750

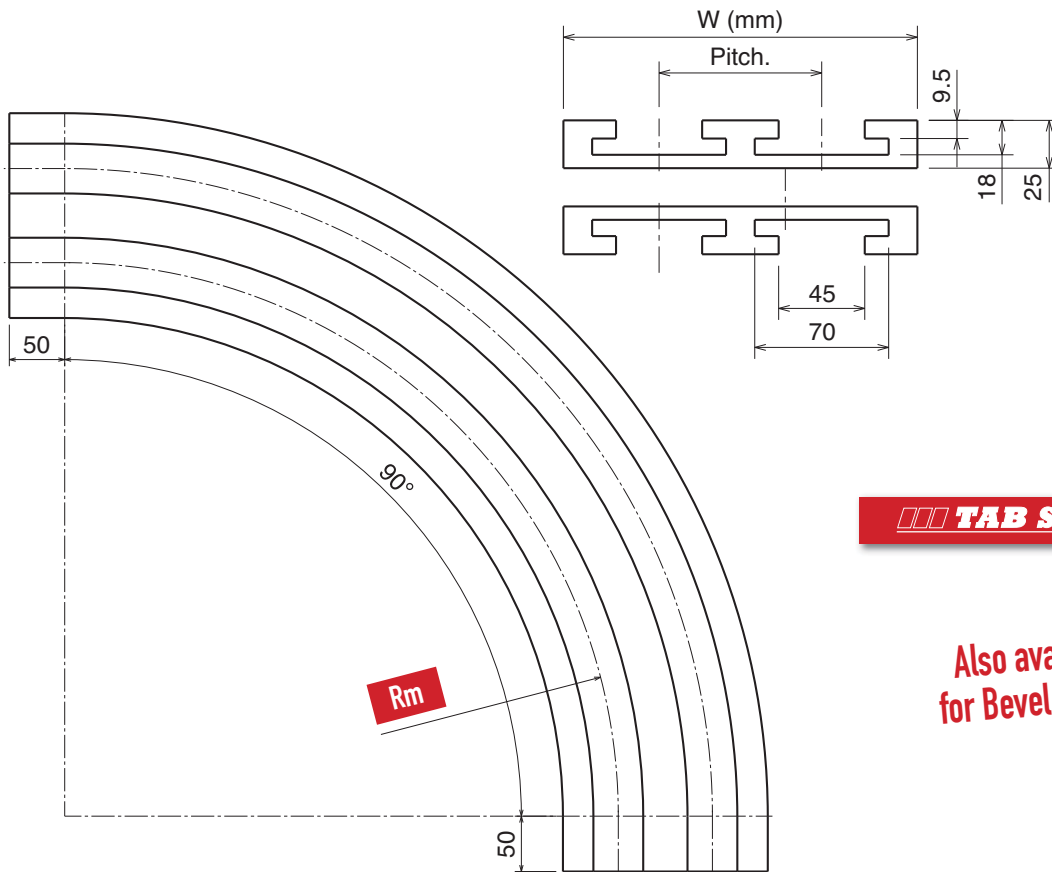

TAB System

Also available for Bevel system

Upper part available, on request, also in **BluLub**  and for abrasive applications.

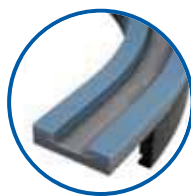
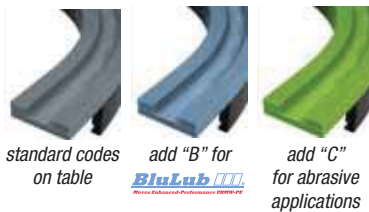

add "RS" for **RS** 

Part	Article-Nr.	Tracks	W	Rm	Pitch
K325					
720	72021612	1	100	500	85
720	72021622	2	185		
720	72021632	3	270		
720	72021642	4	355		
720	72021652	5	440		
720	72021662	6	525		
K450					
721	72123612	1	130	610	120
721	72123622	2	250		
721	72123632	3	370		
721	72123642	4	490		
721	72123652	5	610		
721	72123662	6	720		
K750					
722	72223612	1	200	610	195
722	72223622	2	395		
722	72223632	3	590		
722	72223642	4	785		

Curva 882 TAB K750-K1000-K1200 / Curve 882 TAB K750-K1000-K1200 / Kurve 882 TAB K750-K1000-K1200

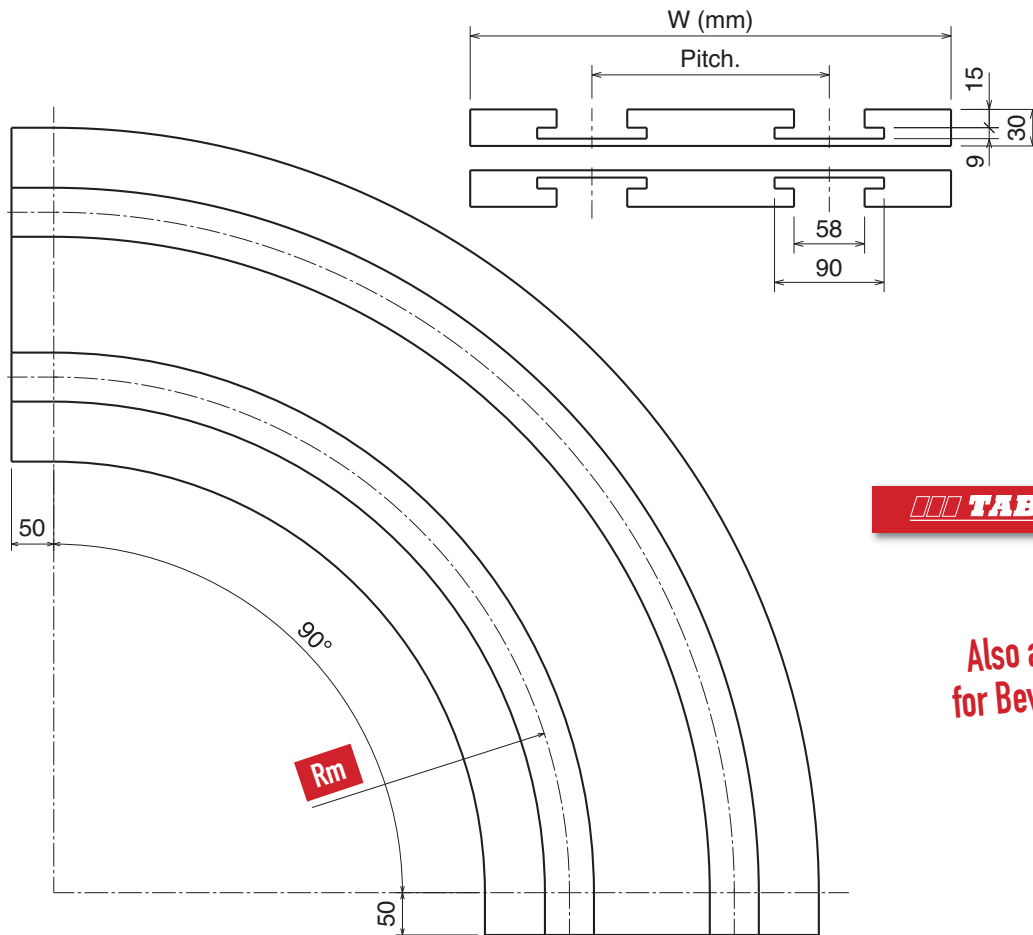

TAB System

Also available
for Bevel system

Upper part available, on request,
also in **BluLub** 
Movex Enhanced-Performance UHMW-PE
and for abrasive applications.

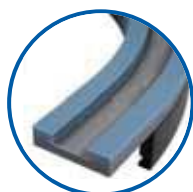
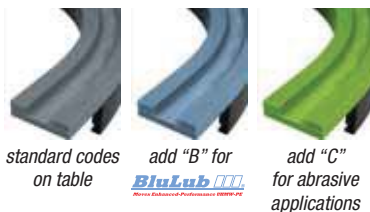

add "RS" for
RS 

Part	Article-Nr.	Tracks	W	Rm	Pitch
K750					
723	72323612	1	200	610	195
723	72323622	2	395		
723	72323632	3	590		
723	72323642	4	785		
K1000					
724	72423612	1	270	610	230
724	72423622	2	530		
724	72423632	3	790		
724	72423642	4	1050		
K1200					
725	72523612	1	320	610	310
725	72523622	2	630		
725	72523632	3	940		
725	72523642	4	1250		